

ATENUACIÓN NATURAL EN DUCTOS					
Ductos		Radio de codo			
Tamaño, in	dB	Tamaño, in	dB		
(pequeños) 6 x 6	0.10	10 x 10	1		
(medianos) 24 x 24	0.05	20 x 20	2		
(grandes) 72 x 72	0.01	más de 20	3		

Ramales					
Relación de CFM en el ramal a CFM en ducto principal, %	5	10	20	30	50
Atenuación, dB	13	10	7	5	3

Anexo 1. Atenuación Natural en Ductos.

Tipo de área	Rango de niveles sonoros A, decibeles	Rango de curvas de criterio NC	Tipo de área	Rango de niveles sonoros A, decibeles	Rango de curvas de criterio NC
RESIDENCIAS			IGLESIAS Y ESCUELAS (Continuación)		
viviendas privadas (rurales y suburbanas)	25-35	20-30	Laboratorios	40-50	35-45
viviendas privadas (urbanas)	30-40	25-35	Salas de juegos	40-55	35-50
Edificios de departamentos, unidades de 2 y 3 familias	35-45	30-40	Corredores y vestíbulos	40-55	35-50
			Cocinas	45-55	40-50
HOTELES			EDIFICIOS PÚBLICOS		
Habitaciones individuales o suites	35-45	30-40	Bibliotecas públicas, museos, juzgados	35-45	30-40
Salones de baile o para banquetes	35-45	30-40	Oficinas de correo, zonas bancarias en general, recibidores	40-50	35-45
Vestíbulos y corredores, recibidores	40-50	35-45	Cuartos de lavado y sanitarios	45-55	40-50
Cocheras	45-55	40-50			
Cocinas y lavanderías	45-55	40-50	RESTAURANTES, CAFETERÍAS, CLUBES		
HOSPITALES Y CLÍNICAS			Restaurants	40-50	35-45
Cuartos privados	30-40	25-35	Barras	40-55	35-50
Quirófanos, antesalas	35-45	30-40	Clubes nocturnos	40-50	35-45
Laboratorios, vestíbulos y corredores	40-50	35-45	Cafeterías	45-55	40-50
Recibidores y salas de espera	40-50	35-45			
Cuartos de lavado y sanitarios	45-55	40-50	TIENDAS DE MENUDEO		
OFICINAS			Tiendas de ropa	40-50	35-45
Sala de consejo	25-35	20-30	Tiendas de departamentos (pisos superiores)		
Salas de conferencias	30-40	25-35	Tiendas de departamentos (planta baja)	45-55	40-50
Oficinas ejecutivas	35-45	30-40	Tiendas pequeñas	45-55	40-50
Oficinas de supervisores, salas de recepción	35-50	30-45	Supermercados		
Oficinas abiertas generales, salas de dibujo	40-50	35-45	ACTIVIDADES DEPORTIVAS BAJO TECIO		
Vestíbulos y corredores	40-55	35-50	Coliseos	35-45	30-40
Tabulación y computación	45-65	40-60	Pistas de boliche, gimnasios	40-50	35-45
AUDITORIOS Y SALAS DE MÚSICA			Albercas	45-60	40-55
Salas de concierto y ópera			TRANSPORTES (FERROCARRIL, AUTOBÚS, AÉREOS)		
Estudios para reproducción sonora	20-30	15-25	Taquillas de boletos	35-45	30-40
Teatros, salas de uso múltiple	30-35	25-30	Salas de espera y de reposo	40-55	35-50
Cines, salas de TV					
Anfiteatros semi-al aire libre	35-45	30-35	CUARTOS DE MÁQUINAS		
Salas de conferencias, planetarios			Para exposiciones menores de 8 h/día	<90	
Recibidores	40-50	35-45	Para exposiciones menores de 3 h/día (o bien de acuerdo a las normas de la OSHA)	<97	
IGLESIAS Y ESCUELAS					
Iglesias	25-35	20-30			
Librerías	35-45	30-40			
Escuelas y salones de clase	35-45	30-40			

NOTA: Lo anterior es para recintos desocupados en donde funcionen todos los sistemas.
Reproducido con autorización del 1976 ASHRAE Handbook & Product Directory.

Anexo 2. Rangos de Metas de Diseño Interior para Control de Ruidos en el Sistema de Acondicionamiento de Aire.

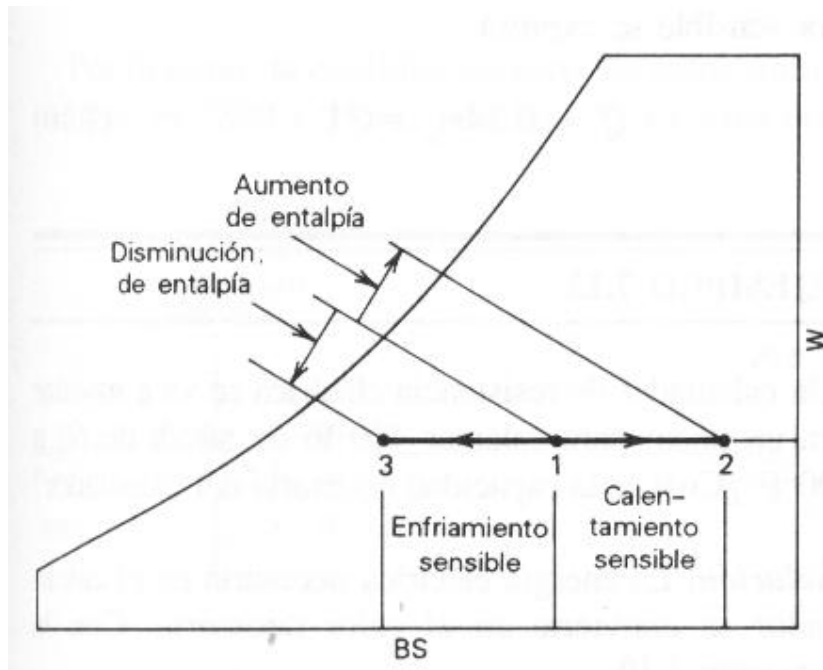

Anexo 3. Proceso de Calentamiento Sensible y Enfriamiento Sensible.

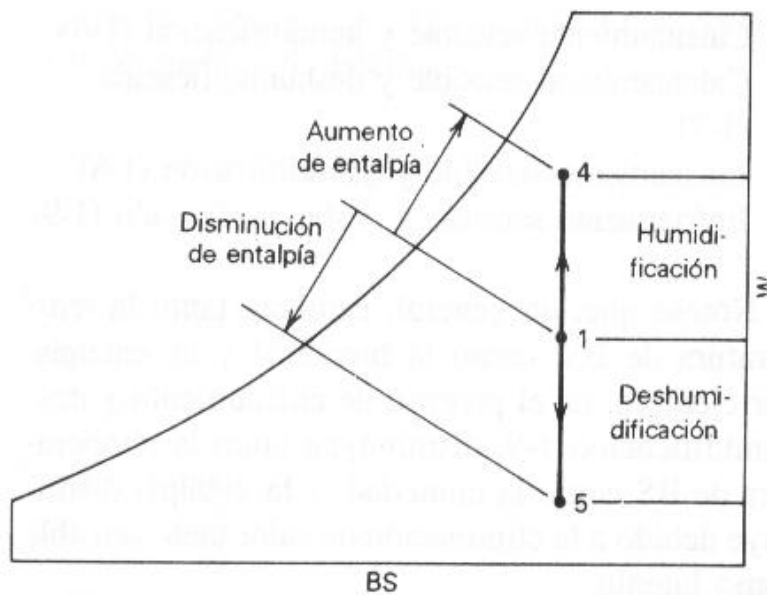

Anexo 4. Procesos de Humidificación y Deshumidificación (Variación de Calor Latente).

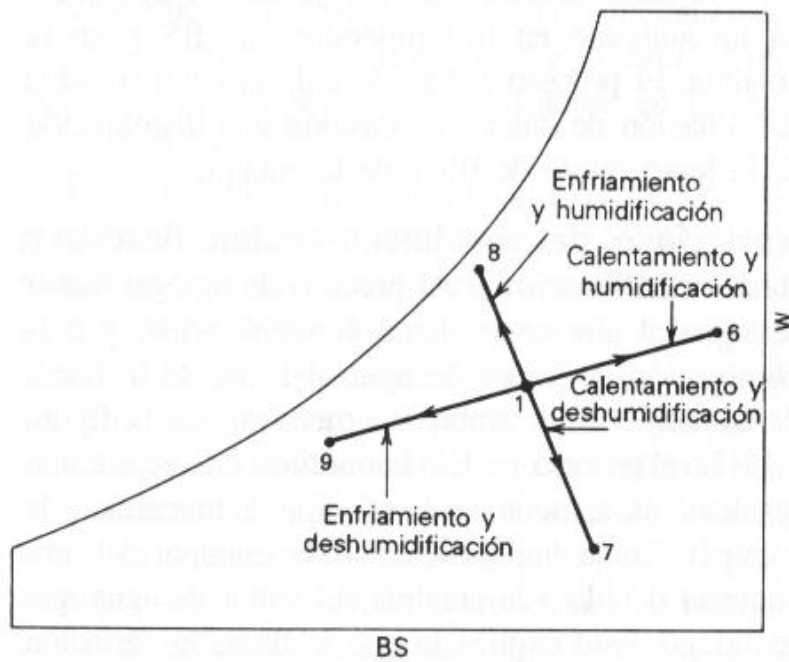

Anexo 5. Procesos Combinados de Cambio de Calor Sensible y Latente.

Mezcla adiabática

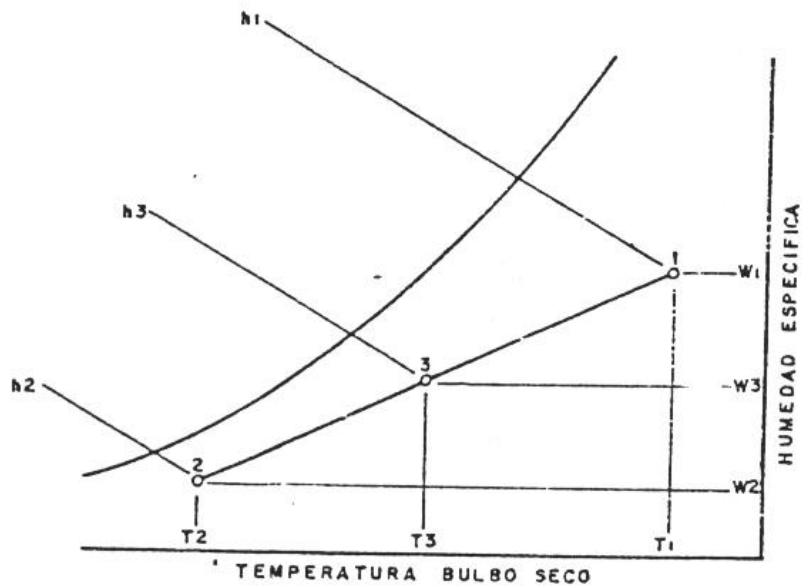

Anexo 6. Proceso de Mezcla Adiabática.

Factores de implementos de sombra

Tipo de vidrio	Factor de vidrio sin protección	Persiana veneciana interior			Persiana enrollable		
		Color claro	Color medio	Color oscuro	Opaca oscura	Opaca clara	Traslucida clara
Vidrio ordinario 3 a 5 mm	1.00	.56	.65	.75	.59	.25	.39
Vidrio regular 6 a 10 mm	.94	.56	.65	.74	.59	.25	.39
Vidrio absorbente							
40 a 48% absorción	.80	.56	.62	.72	.45	.30	.36
48 a 56% absorción	.73	.53	.59	.62	.43	.29	.34
56 a 70% absorción	.62	.51	.54	.56	.40	.28	.32
Vidrio doble							
Vidrio ordinario	.90	.54	.61	.67	.60	.25	.37
Vidrio regular	.80	.52	.59	.65	.60	.25	.37
Vidrio triple							
Vidrio ordinario	.83	.48	.56	.64			
Vidrio regular	.69	.47	.52	.57			
Vidrio de color							
Color ambar	.70						
Rojo oscuro	.56						
Azul oscuro	.60						
Verde oscuro	.32						

Nota: Consulte la literatura de los fabricantes para valores exactos.

Anexo 7. Factores de Implemento de Sombra.

Ciudad	Porcentaje Considerado (%)	Bulbo Seco		Bulbo Húmedo		Rango Diario (°F)
		°C	°F	°C	°F	
Barcelona	0,1	37,4	99,3	32,5	90,5	18,5
	1,0	35,5	95,9	30,8	87,4	
	2,5	34,2	93,6	29,4	84,9	
Barquisimeto	0,1	33,8	92,8	26,8	80,2	21,0
	1,0	31,8	89,2	24,5	76,1	
	2,5	30,9	87,6	24,0	75,2	
Caracas	0,1	32,0	89,6	25,3	77,5	19,3
	1,0	30,5	87,0	23,8	74,8	
	2,5	29,6	85,3	23,3	73,9	
Maracaibo	0,1	36,8	98,2	30,3	86,5	19,3
	1,0	35,3	95,5	29,1	84,4	
	2,5	34,5	94,1	28,6	83,5	
Maracay	0,1	35,6	96,0	30,9	87,6	24,7
	1,0	33,8	92,8	27,0	80,6	
	2,5	32,8	91,0	26,1	79,0	

Anexo 8. Temperatura Exterior de Diseño para Varias Ciudades de Venezuela.

MESES	ORIENTACIÓN				
	N	NE/NO	E/O	SE/SO	S
Marzo	37	152	241	187	65
Junio	83	199	202	86	40
Septiembre	38	145	230	179	65
Diciembre	31	52	211	249	188

Anexo 9. Factores de Ganancia Máxima de Calor Solar para Vidrios Insolados Btu/(hr x pie²) (10° LN).

MESES	ORIENTACIÓN				
	N	NE/NO	E/O	SE/SO	S
Marzo	6	37	39	40	39
Junio	45	47	46	41	40
Septiembre	37	38	41	42	41
Diciembre	30	30	32	36	37

Anexo 10. Factores de Ganancia Máxima de Calor Solar para Vidrios en Sombra Btu/(hr x pie²) (10° LN).

MESES	EXPOSICIÓN	HORA (DÍA)					
		8 a.m.	10 a.m.	12 m.	2 p.m.	4 p.m.	6 p.m.
Marzo 21	N	21	33	37	33	21	12
	NE	152	81	37	32	20	11
	E	241	166	38	32	20	11
	SE	187	152	53	32	20	11
	S	28	54	65	54	28	14
	SO	20	32	52	152	187	144
	O	20	32	38	166	241	195
	NO	20	32	37	81	152	130
Junio 21	N	78	82	82	82	78	64
	NE	199	158	64	36	24	15
	E	202	144	42	35	24	15
	SE	86	55	40	35	24	15
	S	24	36	40	36	24	15
	SO	24	35	40	55	86	70
	O	24	35	42	144	202	166
	NO	24	36	64	158	199	164
Sept. 21	N	22	34	38	34	22	13
	NE	145	80	39	33	21	11
	E	229	162	39	33	21	11
	SE	179	149	53	33	21	11
	S	29	55	65	55	29	14
	SO	21	33	53	149	179	132
	O	21	33	39	162	229	178
	NO	21	33	39	80	145	120
Dic. 21	N	15	27	31	27	15	6
	NE	52	28	31	27	15	6
	E	211	148	32	27	15	6
	SE	238	228	130	31	15	6
	S	121	172	187	172	121	63
	SO	15	31	130	228	238	147
	O	15	27	32	148	211	139
	NO	15	27	31	28	52	44

FGCS = $(A_{vi}/A) \times$ Componente Directa + Componente Difusa

Anexo 11. Factores de Ganancia de Calor Solar para Vidrios en Insolación Parcial Btu/(hr x pie²) (10° LN)

ORIENTACIÓN	HORA (DÍA)					
	8 a.m.	10 a.m.	12 m.	2 p.m.	4 p.m.	6 p.m.
N	0,65 (0,46)	0,80 (0,59)	0,89 (0,70)	0,86 (0,75)	0,75 (0,74)	0,78 (0,75)
NE	0,74 (0,44)	0,37 (0,40)	0,27 (0,33)	0,24 (0,30)	0,20 (0,26)	0,16 (0,23)
E	0,80 (0,44)	0,62 (0,51)	0,27 (0,39)	0,22 (0,32)	0,17 (0,26)	0,14 (0,23)
SE	0,74 (0,38)	0,79 (0,54)	0,49 (0,51)	0,28 (0,40)	0,22 (0,33)	0,18 (0,29)
S	0,23 (0,14)	0,58 (0,31)	0,83 (0,52)	0,68 (0,58)	0,35 (0,47)	0,27 (0,41)
SO	0,14 (0,12)	0,19 (0,15)	0,38 (0,23)	0,75 (0,44)	0,81 (0,58)	0,69 (0,59)
O	0,11 (0,10)	0,15 (0,12)	0,17 (0,14)	0,53 (0,29)	0,82 (0,50)	0,81 (0,56)
NO	0,14 (0,11)	0,19 (0,14)	0,21 (0,17)	0,30 (0,21)	0,73 (0,42)	0,82 (0,51)

NOTA: Los valores entre paréntesis corresponden a los valores de los factores de carga de enfriamiento SIN protección interior.

Anexo 12. Factores de Carga de Enfriamiento con Protección Interior (Persianas).

HORA (DÍA)	8 a.m.	10 a.m.	12 m.	2 p.m.	4 p.m.	6 p.m.
DT (°F)	0	4	9	13	14	13

$$DT_c = DT + (78 - T_r) + (T_0 - 85)$$

Siendo el significado de cada uno de los términos el mismo indicado para paredes y techos exteriores.

Anexo 13. Diferencia de Temperatura a Través de Vidrios Exteriores

	SIN PROTECCIÓN INTERIOR	CON PROTECCIÓN INTERIOR
Vidrio Sencillo	1,04	0,81
Vidrio Doble	0,61	0,55

Anexo 14. Coeficiente Total de Vidrio Exterior Btu/(hr x pie² x °F).

DESCRIPCIÓN	C ₀	L	D	K	C	R	P
Ladrillo Macizo	A1	4	130	0,75	0,22	0,44	43
Ladrillo Común	B1	4	120	0,42	0,20	0,79	40
Concreto Macizo	C1	4	40	0,10	0,20	3,33	13,3
	C2	6	40	0,10	0,20	5,00	20
	C3	8	40	0,10	0,20	6,66	26,7
Bloque Hueco de Arcilla	D1	4	70	0,33	0,20	1,01	23
	D2	8	70	0,33	0,20	2,02	46
Bloque Hueco de Concreto, Agregado de Arena y Grava	E1	4	61	0,47	0,20	0,71	20
	E2	8	61	0,60	0,20	1,11	40
Madera	F1	1	37	0,067	0,60	1,19	3,1
	F2	2	37	0,067	0,60	2,39	6,2
Friso de Cemento y Arena	G1	1	116	0,40	0,20	0,208	9,6
Fieltro Asfáltico	H1	3/8	70	0,11	0,40	0,285	2,2
Escoria Metálica o Piedra	I1	1/2	55	0,83	0,40	0,05	2,3
Yeso o Similar	J1	3/4	100	0,42	0,20	0,149	6,2
Linoleum, Vinyl	K1	1/8	80	0,21	0,30	0,08	0,8
Fibra Mineral (Aislamiento)	L1	1	5,7	0,025	0,20	3,33	0,47
AIRE		POSICIÓN		FLUJO DE CALOR		R	
Aire Quieto	M1	Horizontal		Arriba		0,61	
	M2	Horizontal		Abajo		0,92	
	M3	Vertical		Horizontal		0,68	
Espacio de Aire L = 3/4	N1	Vertical		Horizontal		0,91	
Aire en Movimiento 7,5 MPH	O1	-----		-----		0,25	
Aire en Movimiento < 7,5 MPH (12 Km/hr)	O2	-----		-----		0,33	

L: espesor (pulg.)

D: densidad (lb/pie³)

K: conductividad térmica (Btu/(hr x pie² x °F))

C: calor específico (Btu/(lb x °F))

R: resistencia ((pie² x °F x hr)/Btu)

P: peso (lb/pie²)

C₀: código

Anexo 15. Características Térmicas de Materiales Comúnmente Utilizados y del Aire.

Grupo	Componentes	Peso (lb/pie ²)	U (C _c)	Orientación	HORA (DÍA)					
					8 a.m.	10 a.m.	12 m.	2 p.m.	4 p.m.	6 p.m.
D	O2, A1, B1, J1, M3	90	0,42 (18,8)	N	6	6	7	10	13	17
				NE	8	14	20	23	24	25
				E	9	17	27	32	33	32
	O2, A1, D1, J1, M3	72	0,38 (15,5)	SE	8	13	22	29	32	32
				S	7	6	9	16	24	29
				SO	10	8	8	12	21	32
				O	11	9	9	11	18	30
O2, G1, D2, J1, M3	62	0,30 (12,5)	NO	9	7	8	10	14	22	
			N	4	6	9	13	17	20	
E	O2, G1, E2, J1, M3	56	0,40 (11,3)	NE	9	20	25	26	26	26
				E	11	26	36	37	34	32
				SE	8	19	31	37	36	33
				S	3	5	13	24	32	33
	O2, G1, D1, L1, J1, M3	39	0,18 (8,7)	SO	5	6	9	18	32	43
				O	6	6	9	14	27	43
				NO	5	5	8	13	20	32
F	O2, G1, D1, J1, M3	39	0,42 (7,85)	N	4	7	11	17	21	23
				NE	14	28	29	27	27	26
				E	17	38	45	39	34	30
				SE	10	28	41	42	36	31
	O2, G1, D1, J1, N1, M3	39	0,30 (7,85)	S	1	7	20	34	39	35
				SO	2	5	11	26	44	53
				O	3	6	11	20	39	57
				NO	2	5	10	15	27	42

Condiciones: 40° LN, Julio

Rango Diario: 21 °F

Temperatura Promedio Exterior: 85 °F

Temperatura de Diseño Interior: 78 °F

Color Oscuro

Para otras condiciones utilizar la ecuación de corrección para paredes y techos exteriores.

U: Btu/(hr x pie² x °F)

C_c: Btu/(pie² x °F)

Para paredes en sombra considere los valores correspondientes a la orientación norte.

Cuando los componentes de paredes exteriores no se correspondan con los componentes de los grupos indicados, se deberá seleccionar el grupo "similar" tomando en consideración el peso y la capacidad calórica total del material.

Anexo 16. Diferencias de Temperatura para Determinar la Carga de Enfriamiento por Paredes Exteriores (°F).

Ecuación de Corrección para Paredes y Techos Exteriores.

$$DT_c = (DT + LM) \times K + (78 - T_r) + (T_0 - 85)$$

Siendo:

DT_c : valor corregido de DT , °F.

DT : diferencia de temperatura, °F (Anexo 16).

LM : corrección por latitud y mes (Anexo 17).

K : corrección por color de la superficie

- $K = 1$ color oscuro
- $K = 0,5$ techo color claro
- $K = 0,65$ pared color claro

T_r : temperatura de diseño interior, °F.

T_0 : temperatura promedio exterior, °F.

$$T_0 = T_E - (\text{rango diario}/2)$$

Siendo:

T_E : temperatura de diseño exterior, °F.

Rango Diario : diferencia entre el máximo promedio y el mínimo promedio de temperatura para el mes más caluroso, °F (Ver anexo 8).

MESES	ORIENTACIÓN						
	N	NE/NO	E	S	SE/SO	O	HORIZONTAL
Diciembre	- 4,00	- 6,50	- 3,25	12,25	4,00	- 3,25	- 6,00
Enero – Noviembre	- 3,25	- 6,25	- 2,50	10,50	3,25	- 2,50	- 4,75
Febrero – Octubre	- 3,00	- 3,50	- 1,25	4,75	1,25	- 1,25	- 1,75
Marzo – Septiembre	- 3,00	- 1,25	- 1,00	- 3,00	- 1,50	- 1,00	- 0,25
Abril – Agosto	1,25	1,25	- 1,00	- 6,75	- 4,50	- 1,00	- 0,75
Mayo – Julio	6,25	3,75	- 1,75	- 7,00	- 6,50	- 1,75	- 1,50
Junio	8,25	4,00	- 1,75	- 7,00	- 7,50	- 1,75	- 1,50

Para paredes en sombra considere los valores correspondientes a la orientación norte.

Anexo 17. Correcciones de las Diferencias de Temperatura en °F de Paredes y Techos Exteriores por Latitud y Mes (10° LN).

Lights On For	Number of Hours after Lights Turned On																								
	1	2	3	4	5	6	7	8	9	10	11	12	13	14	15	16	17	18	19	20	21	22	23	24	
Zone Type A																									
8	0.85	0.92	0.95	0.96	0.97	0.97	0.97	0.98	0.98	0.13	0.06	0.04	0.03	0.02	0.02	0.02	0.01	0.01	0.01	0.01	0.01	0.01	0.01	0.01	0.01
10	0.85	0.93	0.95	0.96	0.97	0.97	0.98	0.98	0.98	0.98	0.98	0.14	0.07	0.04	0.03	0.02	0.02	0.02	0.02	0.02	0.02	0.01	0.01	0.01	0.01
12	0.86	0.93	0.96	0.97	0.97	0.98	0.98	0.98	0.98	0.98	0.98	0.14	0.07	0.04	0.03	0.03	0.03	0.02	0.02	0.02	0.02	0.02	0.02	0.02	0.02
14	0.86	0.93	0.96	0.97	0.98	0.98	0.98	0.98	0.98	0.98	0.99	0.99	0.99	0.99	0.15	0.07	0.05	0.03	0.03	0.03	0.03	0.02	0.02	0.02	0.02
16	0.87	0.94	0.96	0.97	0.98	0.98	0.98	0.99	0.99	0.99	0.99	0.99	0.99	0.99	0.15	0.08	0.05	0.04	0.03	0.03	0.03	0.03	0.03	0.03	0.02
Zone Type B																									
8	0.75	0.85	0.90	0.93	0.94	0.95	0.95	0.96	0.96	0.23	0.12	0.08	0.05	0.04	0.04	0.03	0.03	0.03	0.02	0.02	0.02	0.02	0.02	0.02	0.01
10	0.75	0.86	0.91	0.93	0.94	0.95	0.95	0.96	0.96	0.97	0.97	0.24	0.13	0.08	0.06	0.05	0.04	0.04	0.03	0.03	0.03	0.03	0.02	0.02	0.02
12	0.76	0.86	0.91	0.93	0.95	0.95	0.96	0.96	0.97	0.97	0.97	0.24	0.14	0.09	0.07	0.05	0.05	0.04	0.04	0.04	0.03	0.03	0.03	0.03	0.03
14	0.76	0.87	0.92	0.94	0.95	0.96	0.96	0.97	0.97	0.97	0.97	0.25	0.14	0.09	0.07	0.05	0.05	0.04	0.04	0.04	0.04	0.03	0.03	0.03	0.03
16	0.77	0.88	0.92	0.95	0.96	0.96	0.97	0.97	0.97	0.98	0.98	0.25	0.15	0.10	0.09	0.07	0.06	0.05	0.05	0.05	0.05	0.04	0.04	0.04	0.03
Zone Type C																									
8	0.72	0.80	0.84	0.87	0.88	0.89	0.90	0.91	0.92	0.23	0.15	0.11	0.09	0.08	0.07	0.07	0.06	0.05	0.05	0.04	0.04	0.03	0.03	0.03	0.03
10	0.73	0.81	0.85	0.87	0.89	0.90	0.91	0.92	0.92	0.92	0.93	0.25	0.16	0.13	0.11	0.09	0.08	0.08	0.07	0.06	0.06	0.05	0.05	0.04	0.04
12	0.74	0.82	0.86	0.88	0.90	0.91	0.92	0.92	0.92	0.93	0.94	0.26	0.18	0.14	0.12	0.10	0.09	0.08	0.08	0.08	0.07	0.06	0.06	0.06	0.05
14	0.75	0.84	0.87	0.89	0.91	0.92	0.92	0.93	0.94	0.94	0.94	0.27	0.19	0.15	0.12	0.10	0.09	0.08	0.08	0.08	0.07	0.06	0.06	0.06	0.05
16	0.77	0.85	0.89	0.91	0.92	0.93	0.93	0.94	0.95	0.95	0.95	0.28	0.20	0.16	0.13	0.11	0.09	0.08	0.08	0.08	0.07	0.06	0.06	0.06	0.05
Zone Type D																									
8	0.66	0.72	0.76	0.79	0.81	0.83	0.85	0.86	0.86	0.25	0.20	0.17	0.15	0.13	0.12	0.11	0.10	0.09	0.08	0.07	0.06	0.06	0.05	0.04	0.04
10	0.68	0.74	0.77	0.80	0.82	0.84	0.86	0.87	0.88	0.90	0.28	0.23	0.19	0.17	0.15	0.14	0.12	0.11	0.10	0.09	0.08	0.07	0.06	0.06	0.06
12	0.70	0.75	0.79	0.81	0.83	0.85	0.87	0.88	0.89	0.90	0.30	0.25	0.21	0.19	0.17	0.15	0.13	0.12	0.11	0.10	0.09	0.08	0.07	0.06	0.06
14	0.72	0.77	0.81	0.83	0.85	0.86	0.88	0.89	0.90	0.91	0.32	0.26	0.22	0.19	0.17	0.15	0.13	0.12	0.11	0.10	0.09	0.08	0.07	0.06	0.06
16	0.75	0.80	0.83	0.85	0.87	0.88	0.89	0.90	0.91	0.92	0.34	0.28	0.24	0.21	0.19	0.17	0.15	0.13	0.12	0.11	0.10	0.09	0.08	0.07	0.06

Note: See Table 35 for zone type. Data based on a radiative/convective fraction of 0.59/0.41.

Anexo 18. Factor de Carga de Enfriamiento para Luces.

Table 20 Zone Parametric Level Definitions

No.	Parameter	Meaning	Levels (in normal order)
1	ZG	Zone geometry	100 ft × 20 ft, 15 ft × 15 ft, 100 ft × 100 ft
2	ZH	Zone height	8 ft, 10 ft, 20 ft
3	NW	No. exterior walls	1, 2, 3, 4, 0
4	IS	Interior shade	100, 50, 0%
5	FN	Furniture	With, Without
6	EC	Exterior wall construction	1, 2, 3, 4 (Table 21)
7	PT	Partition type	5/8 in. gypsum board-air space 5/8 in. gypsum board, 8 in. concrete block
8	ZL	Zone location	Single-story, top floor, bottom floor, mid-floor
9	MF	Mid-floor type	8 in. concrete, 2.5 in. concrete, 1 in. wood
10	ST	Slab type	Mid-floor type, 4 in. slab on 12 in. soil
11	CT	Ceiling type	3/4 in. acoustic tile and air space, w/o ceiling
12	RT	Roof type	1, 2, 3, 4 (Table 23)
13	FC	Floor covering	Carpet with rubber pad, vinyl tile
14	GL	Glass percent	10, 50, 90

Anexo 19. Definiciones de los Niveles Paramétricos de la Zona.

Table 21 Exterior Wall Construction Types

Type	Description
1	Outside surface resistance, 1 in. stucco, 1 in. insulation, 3/4 in. plaster or gypsum, inside surface resistance (A0, A1, B1, E1, E0)*
2	Outside surface resistance, 1 in. stucco, 8 in. HW concrete, 3/4 in. plaster or gypsum, inside surface resistance (A0, A1, C10, E1, E0)
3	Outside surface resistance, steel siding, 3 in. insulation, steel siding, inside surface (A0, A3, B12, A3, E0)*
4	Outside surface resistance, 4 in. face brick, 2 in. insulation, 12 in. HW concrete, 3/4 in. plaster or gypsum, inside surface resistance (A0, A2, B3, C11, E1, E0)*

Note: Code letters are defined in Table 11.

Anexo 20. Tipos de Construcción de Pared Exterior.

Table 23 Roof Construction Types

Type	Description
1	Outside surface resistance, 1/2 in. slag or stone, 3/8 in. felt membrane, 1 in. insulation, steel siding, inside surface resistance (A0, E2, E3, B4, A3, E0)*
2	Outside surface resistance, 1/2 in. slag or stone, 3/8 in. felt membrane, 6 in. LW concrete, inside surface resistance (A0, E2, E3, C15, E0)*
3	Outside surface resistance, 1/2 in. slag or stone, 3/8 in. felt membrane, 2 in. insulation, steel siding, ceiling air space, acoustic tile, inside surface resistance (A0, E2, E3, B6, A3, E4, E5, E0)*
4	Outside surface resistance, 1/2 in. slag or stone, 3/8 in. felt membrane, 8 in. LW concrete, ceiling air space, acoustic tile, inside surface resistance (A0, E2, E3, C16, E4, E5, E0)*

Note: Code letters are defined in Table 11.

Anexo 21. Tipos de Construcción de Techos.

Table 11 Thermal Properties and Code Numbers of Layers Used in Wall and Roof Descriptions for Tables 12 and 13

Code Number	Description	Thickness and Thermal Properties					
		L	k	ρ	c _p	R	Mass
A0	Outside surface resistance	0.0	0.0	0.0	0.0	0.33	0.0
A1	1 in. Gypsum	0.0923	0.4	116.0	0.20	0.21	0.7
A2	4 in. Face brick	0.333	0.77	125.0	0.22	0.43	41.7
A3	Steel siding	0.005	26.0	480.0	0.10	0.00	2.4
A4	1/2 in. Slag	0.0417	0.11	70.0	0.40	0.38	2.2
A5	Outside surface resistance	0.0	0.0	0.0	0.0	0.22	0.0
A6	Plaster	0.0417	0.24	70.0	0.26	0.17	3.2
A7	4 in. Face brick	0.333	0.77	125.0	0.22	0.43	41.7
B1	Air space resistance	0.0	0.0	0.0	0.0	0.01	0.0
B2	1 in. Insulation	0.083	0.025	2.0	0.2	3.33	0.2
B3	2 in. Insulation	0.167	0.025	2.0	0.2	6.67	0.3
B4	3 in. Insulation	0.25	0.025	2.0	0.2	1.19	0.5
B5	1 in. Insulation	0.0923	0.025	5.7	0.2	2.22	0.5
B6	2 in. Insulation	0.167	0.025	5.7	0.2	6.67	1.0
B7	1 in. Wood	0.0833	0.07	37.0	0.6	1.19	3.1
B8	2.5 in. Wood	0.2083	0.07	37.0	0.6	2.98	7.7
B9	4 in. Wood	0.333	0.07	37.0	0.6	4.76	12.1
B10	2 in. Wood	0.167	0.07	37.0	0.6	2.39	6.2
B11	3 in. Wood	0.25	0.07	37.0	0.6	3.57	9.3
B12	3 in. Insulation	0.25	0.025	5.7	0.2	10.00	1.4
B13	4 in. Insulation	0.333	0.025	5.7	0.2	13.33	1.8
B14	5 in. Insulation	0.417	0.025	5.7	0.2	16.67	2.4
B15	6 in. Insulation	0.500	0.025	5.7	0.2	20.00	2.9
B16	0.15 in. Insulation	0.0126	0.025	5.7	0.2	0.50	0.1
B17	0.2 in. Insulation	0.025	0.025	5.7	0.2	1.00	0.1
B18	0.45 in. Insulation	0.0379	0.025	5.7	0.2	1.50	0.2
B19	0.61 in. Insulation	0.0505	0.025	5.7	0.2	2.00	0.3
B20	0.76 in. Insulation	0.0631	0.025	5.7	0.2	2.50	0.4
B21	1.26 in. Insulation	0.1126	0.025	5.7	0.2	4.50	0.6
B22	1.67 in. Insulation	0.1388	0.025	5.7	0.2	5.50	0.8
B23	2.42 in. Insulation	0.2019	0.025	5.7	0.2	8.00	1.2
B24	2.73 in. Insulation	0.2272	0.025	5.7	0.2	9.00	1.3
B25	3.33 in. Insulation	0.3333	0.025	5.7	0.2	11.00	1.6
B26	2.64 in. Insulation	0.2020	0.025	5.7	0.2	12.00	1.7
B27	4.34 in. Insulation	0.3786	0.025	5.7	0.2	15.00	2.2
C1	4 in. Clay tile	0.333	0.33	70.0	0.2	1.01	23.3
C2	4 in. Lightweight concrete block	0.333	0.22	38.0	0.2	1.51	12.7
C3	4 in. Heavyweight concrete block	0.333	0.47	61.0	0.2	0.71	20.3
C4	4 in. Common brick	0.333	0.42	120.0	0.2	0.70	40.0
C5	4 in. Heavyweight concrete	0.333	1.0	140.0	0.2	0.33	46.7
C6	8 in. Clay tile	0.667	0.33	70.0	0.2	2.00	46.7
C7	8 in. Lightweight concrete block	0.667	0.33	38.0	0.2	2.00	25.3
C8	8 in. Heavyweight concrete block	0.667	0.6	61.0	0.2	1.11	40.7
C9	8 in. Common brick	0.667	0.42	120.0	0.2	1.59	80.0
C10	8 in. Heavyweight concrete	0.667	1.0	140.0	0.2	0.67	93.4
C11	12 in. Heavyweight concrete	1.0	1.0	140.0	0.2	1.00	140.0
C12	2 in. Heavyweight concrete	0.167	1.0	140.0	0.2	0.17	23.3
C13	6 in. Heavyweight concrete	0.5	1.0	140.0	0.2	0.50	70.0
C14	4 in. Lightweight concrete	0.333	0.1	40.0	0.2	3.33	13.3
C15	6 in. Lightweight concrete	0.5	0.1	40.0	0.2	5.00	20.0
C16	8 in. Lightweight concrete	0.667	0.1	40.0	0.2	6.67	26.7
C17	8 in. Lightweight concrete block (filled)	0.667	0.06	18.0	0.2	8.34	12.0
C18	8 in. Heavyweight concrete block (filled)	0.667	0.34	53.0	0.2	1.96	35.4
C19	12 in. Lightweight concrete block (filled)	1.000	0.08	19.0	0.2	12.50	19.0
C20	12 in. Heavyweight concrete block (filled)	1.000	0.29	55.0	0.2	2.56	56.0
E0	Inside surface resistance	0.0	0.0	0.0	0.0	0.69	0.0
E1	3/4 in. Plaster or gypsum	0.0675	0.42	100.0	0.2	0.15	6.3
E2	1/2 in. Slag or stone	0.0417	0.83	55.0	0.40	0.05	2.3
E3	3/8 in. Felt and membrane	0.0313	0.11	70.0	0.40	0.29	2.2
E4	Ceiling air space	0.0	0.0	0.0	0.0	1.00	0.0
E5	Acoustic tile	0.0675	0.025	20.0	0.2	1.50	1.0

L = thickness, ft
k = thermal conductivity, Btu/h · ft · °F
ρ = density, lb/ft³
c_p = specific heat, Btu/lb · °F
R = thermal resistance, °F · ft² · h/Btu
Mass = unit mass, lb/ft²

Anexo 22. Propiedades Térmicas y Números del Código de Superficies Usadas en la Descripción de Paredes y Techos.

Table 35A Zone Types for Use with CLF Tables, Interior Rooms

Room Location	Zone Parameters ^a			Zone Type	
	Middle Floor	Ceiling Type	Floor Covering	People and Equipment	Lights
Single story	N/A	N/A	Carpet	C	B
	N/A	N/A	Vinyl	D	C
Top floor	2.5 in. Concrete	With	Carpet	D	C
	2.5 in. Concrete	With	Vinyl	D	D
	2.5 in. Concrete	Without	b	D	B
	1 in. Wood	b	b	D	B
Bottom floor	2.5 in. Concrete	With	Carpet	D	C
	2.5 in. Concrete	b	Vinyl	D	D
	2.5 in. Concrete	Without	Carpet	D	D
	1 in. Wood	b	Carpet	D	C
	1 in. Wood	b	Vinyl	D	D
Mid-floor	2.5 in. Concrete	N/A	Carpet	D	C
	2.5 in. Concrete	N/A	Vinyl	D	D
	1 in. Wood	N/A	b	C	B

^aA total of 14 zone parameters is fully defined in Table 20. Those not shown in this table were selected to achieve an error band of approximately 10%.

^bThe effect of this parameter is negligible in this case.

Anexo 23. Tipos de Zona para Usar con las Tablas de Factor de Carga de Enfriamiento para Cuartos Interiores.

Table 35B Zone Types for Use with SCL and CLF Tables, Single-Story Building

No. Walls	Zone Parameters ^a			Zone Type			Error Band	
	Floor Covering	Partition Type	Inside Shade	Glass Solar	People and Equipment	Lights	Plus	Minus
1 or 2	Carpet	Gypsum	b	A	B	B	9	2
1 or 2	Carpet	Concrete block	b	B	C	C	9	0
1 or 2	Vinyl	Gypsum	Full	B	C	C	9	0
1 or 2	Vinyl	Gypsum	Half to None	C	C	C	16	0
1 or 2	Vinyl	Concrete block	Full	C	D	D	8	0
1 or 2	Vinyl	Concrete block	Half to None	D	D	D	10	6
3	Carpet	Gypsum	b	A	B	B	9	2
3	Carpet	Concrete block	Full	A	B	B	9	2
3	Carpet	Concrete block	Half to None	B	B	B	9	0
3	Vinyl	Gypsum	Full	B	C	C	9	0
3	Vinyl	Gypsum	Half to None	C	C	C	16	0
3	Vinyl	Concrete block	Full	B	C	C	9	0
3	Vinyl	Concrete block	Half to None	C	C	C	16	0
4	Carpet	Gypsum	b	A	B	B	6	3
4	Vinyl	Gypsum	Full	B	C	C	11	6
4	Vinyl	Gypsum	Half to None	C	C	C	19	-1

^aA total of 14 zone parameters is fully defined in Table 20. Those not shown in this table were selected to achieve the minimum error band shown in the righthand column for Solar Cooling

Load (SCL). The error band for Lights and People and Equipment is approximately 10%.
^bThe effect of inside shade is negligible in this case.

Anexo 24. Tipos de Zona para Usar con las Tablas de Factor de Carga de Enfriamiento para Edificios.

Hours in Space	Number of Hours after Entry into Space or Equipment Turned On																							
	1	2	3	4	5	6	7	8	9	10	11	12	13	14	15	16	17	18	19	20	21	22	23	24
Zone Type A																								
2	0.75	0.88	0.18	0.08	0.04	0.02	0.01	0.01	0.01	0.01	0.00	0.00	0.00	0.00	0.00	0.00	0.00	0.00	0.00	0.00	0.00	0.00	0.00	0.00
4	0.75	0.88	0.93	0.95	0.22	0.10	0.05	0.03	0.02	0.02	0.01	0.01	0.01	0.01	0.01	0.00	0.00	0.00	0.00	0.00	0.00	0.00	0.00	0.00
6	0.75	0.88	0.93	0.95	0.97	0.97	0.23	0.11	0.06	0.04	0.03	0.02	0.02	0.01	0.01	0.01	0.01	0.00	0.00	0.00	0.00	0.00	0.00	0.00
8	0.75	0.88	0.93	0.95	0.97	0.97	0.98	0.98	0.24	0.11	0.06	0.04	0.03	0.02	0.02	0.01	0.01	0.01	0.01	0.01	0.01	0.00	0.00	0.00
10	0.75	0.88	0.93	0.95	0.97	0.97	0.98	0.98	0.99	0.99	0.24	0.12	0.07	0.04	0.03	0.02	0.02	0.01	0.01	0.01	0.01	0.01	0.01	0.00
12	0.75	0.88	0.93	0.96	0.97	0.98	0.98	0.98	0.99	0.99	0.99	0.99	0.25	0.12	0.07	0.04	0.03	0.02	0.02	0.02	0.01	0.01	0.01	0.01
14	0.76	0.88	0.93	0.96	0.97	0.98	0.98	0.99	0.99	0.99	0.99	0.99	1.00	1.00	0.25	0.12	0.07	0.05	0.03	0.03	0.02	0.02	0.01	0.01
16	0.76	0.89	0.94	0.96	0.97	0.98	0.98	0.99	0.99	0.99	0.99	0.99	1.00	1.00	1.00	1.00	0.25	0.12	0.07	0.05	0.03	0.03	0.02	0.02
18	0.77	0.89	0.94	0.96	0.97	0.98	0.98	0.99	0.99	0.99	0.99	1.00	1.00	1.00	1.00	1.00	1.00	0.25	0.12	0.07	0.05	0.03	0.03	0.03
Zone Type B																								
2	0.65	0.74	0.16	0.11	0.08	0.06	0.05	0.04	0.03	0.02	0.02	0.01	0.01	0.01	0.01	0.00	0.00	0.00	0.00	0.00	0.00	0.00	0.00	0.00
4	0.65	0.75	0.81	0.85	0.24	0.17	0.13	0.10	0.07	0.06	0.04	0.03	0.03	0.02	0.02	0.01	0.01	0.01	0.01	0.00	0.00	0.00	0.00	0.00
6	0.65	0.75	0.81	0.85	0.89	0.91	0.29	0.20	0.15	0.12	0.09	0.07	0.05	0.04	0.03	0.02	0.02	0.01	0.01	0.01	0.01	0.01	0.01	0.00
8	0.65	0.75	0.81	0.85	0.89	0.91	0.93	0.95	0.31	0.22	0.17	0.13	0.10	0.08	0.06	0.05	0.04	0.03	0.02	0.02	0.01	0.01	0.01	0.01
10	0.65	0.75	0.81	0.85	0.89	0.91	0.93	0.95	0.96	0.97	0.33	0.24	0.18	0.14	0.11	0.08	0.06	0.05	0.04	0.03	0.02	0.02	0.01	0.01
12	0.66	0.76	0.81	0.86	0.89	0.92	0.94	0.95	0.96	0.97	0.98	0.98	0.34	0.24	0.19	0.14	0.11	0.08	0.06	0.05	0.04	0.03	0.02	0.02
14	0.67	0.76	0.82	0.86	0.89	0.92	0.94	0.95	0.96	0.97	0.98	0.98	0.99	0.99	0.35	0.25	0.19	0.15	0.11	0.09	0.07	0.05	0.04	0.03
16	0.69	0.78	0.83	0.87	0.90	0.92	0.94	0.95	0.96	0.97	0.98	0.98	0.99	0.99	0.99	0.99	0.35	0.25	0.19	0.15	0.11	0.09	0.07	0.05
18	0.71	0.80	0.85	0.88	0.91	0.93	0.95	0.96	0.97	0.98	0.98	0.99	0.99	0.99	0.99	0.99	1.00	1.00	0.35	0.25	0.19	0.15	0.11	0.09
Zone Type C																								
2	0.60	0.68	0.14	0.11	0.09	0.07	0.06	0.05	0.04	0.03	0.03	0.02	0.02	0.01	0.01	0.01	0.01	0.01	0.01	0.00	0.00	0.00	0.00	0.00
4	0.60	0.68	0.74	0.79	0.23	0.18	0.14	0.12	0.10	0.08	0.06	0.05	0.04	0.04	0.03	0.02	0.02	0.02	0.01	0.01	0.01	0.01	0.01	0.01
6	0.61	0.69	0.74	0.79	0.83	0.86	0.28	0.22	0.18	0.15	0.12	0.10	0.08	0.07	0.06	0.05	0.04	0.03	0.03	0.02	0.02	0.01	0.01	0.01
8	0.61	0.69	0.75	0.79	0.83	0.86	0.89	0.91	0.32	0.26	0.21	0.17	0.14	0.11	0.09	0.08	0.06	0.05	0.04	0.04	0.03	0.02	0.02	0.02
10	0.62	0.70	0.75	0.80	0.83	0.86	0.89	0.91	0.92	0.94	0.35	0.28	0.23	0.18	0.15	0.12	0.10	0.08	0.07	0.06	0.05	0.04	0.03	0.03
12	0.63	0.71	0.76	0.81	0.84	0.87	0.89	0.91	0.93	0.94	0.95	0.96	0.37	0.29	0.24	0.19	0.16	0.13	0.11	0.09	0.07	0.06	0.05	0.04
14	0.65	0.72	0.77	0.82	0.85	0.88	0.90	0.92	0.93	0.94	0.95	0.96	0.97	0.97	0.38	0.30	0.25	0.20	0.17	0.14	0.11	0.09	0.08	0.06
16	0.68	0.74	0.79	0.83	0.86	0.89	0.91	0.92	0.94	0.95	0.96	0.96	0.97	0.98	0.98	0.98	0.39	0.31	0.25	0.21	0.17	0.14	0.11	0.09
18	0.72	0.78	0.82	0.85	0.88	0.90	0.92	0.93	0.94	0.95	0.96	0.97	0.97	0.98	0.98	0.99	0.99	0.99	0.39	0.31	0.26	0.21	0.17	0.14
Zone Type D																								
2	0.59	0.67	0.13	0.09	0.08	0.06	0.05	0.05	0.04	0.04	0.03	0.03	0.02	0.02	0.02	0.01	0.01	0.01	0.01	0.01	0.01	0.01	0.01	0.00
4	0.60	0.67	0.72	0.76	0.20	0.16	0.13	0.11	0.10	0.08	0.07	0.06	0.05	0.05	0.04	0.03	0.03	0.03	0.02	0.02	0.02	0.01	0.01	0.01
6	0.61	0.68	0.73	0.77	0.80	0.83	0.26	0.20	0.17	0.15	0.13	0.11	0.09	0.08	0.07	0.06	0.05	0.05	0.04	0.03	0.03	0.03	0.02	0.02
8	0.62	0.69	0.74	0.77	0.80	0.83	0.85	0.87	0.30	0.24	0.20	0.17	0.15	0.13	0.11	0.10	0.08	0.07	0.06	0.05	0.05	0.04	0.04	0.03
10	0.63	0.70	0.75	0.78	0.81	0.84	0.86	0.88	0.89	0.91	0.33	0.27	0.22	0.19	0.17	0.14	0.12	0.11	0.09	0.08	0.07	0.06	0.05	0.05
12	0.65	0.71	0.76	0.79	0.82	0.84	0.87	0.88	0.90	0.91	0.92	0.93	0.35	0.29	0.24	0.21	0.18	0.16	0.13	0.12	0.10	0.09	0.08	0.07
14	0.67	0.73	0.78	0.81	0.83	0.86	0.88	0.89	0.91	0.92	0.93	0.94	0.95	0.95	0.37	0.30	0.25	0.22	0.19	0.16	0.14	0.12	0.11	0.09
16	0.70	0.76	0.80	0.83	0.85	0.87	0.89	0.90	0.92	0.93	0.94	0.95	0.95	0.96	0.96	0.97	0.38	0.31	0.26	0.23	0.20	0.17	0.15	0.13
18	0.74	0.80	0.83	0.85	0.87	0.89	0.91	0.92	0.93	0.94	0.95	0.95	0.96	0.97	0.97	0.97	0.98	0.98	0.39	0.32	0.27	0.23	0.20	0.17

Note: See Table 35 for zone type. Data based on a radiative/convective fraction of 0.70/0.30.

Anexo 25. Factor de Carga de Enfriamiento para Personas y Equipos sin Campana.

Actividad	Aplicación Típica	T _{bs} = 75 °F		T _{bs} = 73 °F		T _{bs} = 70 °F	
		Sensible	Latente	Sensible	Latente	Sensible	Latente
Sentado, en reposo.	Teatros	230	120	242	108	260	90
Sentado, trabajo liviano.	Escuela Secundaria	240	160	254	146	275	125
Sentado, trabajo ligero.	Oficinas, hoteles	245	205	260	190	285	165

De pie, caminando despacio.	Tiendas, almacenes	245	205	260	190	285	165
De pie, caminando despacio.	Bancos	255	245	270	230	290	210
Sentado, comiendo.	Restaurante	280	270	296	254	320	230
Baile moderado.	Salones de baile	456	824	493	787	548	732
Trabajo pesado.	Fábricas	525	925	557	893	605	845

Anexo 26. Ganancia de Calor por Ocupantes del Ambiente Acondicionado en Btu/hr.

GANANCIAS DEBIDAS AL VENTILADOR DE INSUFLACIÓN
Ventilador situado después de las baterías *****

	ALTURA MANOMÉTRICA TOTAL ** mm C.A.	INSTALACIÓN CENTRALIZADA ***					INSTALACIÓN NO CENTRALIZADA (ARMARIO) ****				
		DIFERENCIA DE TEMPERATURA ENTRE EL AIRE DEL LOCAL Y EL AIRE IMPULSADO (°C)									
		5°	7°5	10°	12°5	15°	5°	7°5	10°	12°5	15°
PORCENTAJE DE LAS GANANCIAS SENSIBLES DEL LOCAL *											
	10	0,99	0,66	0,49	0,40	0,33	2,00	1,34	1,00	0,80	0,67
	15	1,32	0,88	0,66	0,53	0,44	3,30	2,20	1,65	1,32	1,10
	20	2,67	1,78	1,33	1,07	0,89	4,35	2,90	2,17	1,74	1,45
MOTOR DEL VENTILADOR EN EL EXTERIOR DEL LOCAL ACONDICIONADO O DEL CIRCUITO DE AIRE	30	4,00	2,66	2,00	1,60	1,33	6,66	4,44	3,33	2,66	2,22
	40	5,34	3,56	2,67	2,15	1,78	9,00	6,00	4,50	3,60	3,00
	50	7,00	4,68	3,50	2,81	2,34	11,70	7,80	5,85	4,68	3,90
	60	8,34	5,56	4,17	3,34	2,78	13,74	9,16	6,87	5,50	4,58
	80	12,30	8,20	6,15	4,91	4,10	20,40	13,60	10,20	8,15	6,80
	100	16,35	10,90	8,17	6,54	5,45					
	125	21,60	14,40	10,80	8,64	7,20					
	150	27,30	18,20	13,65	10,10	9,10					
	200	42,00	28,00	21,00	16,70	14,00					
MOTOR DEL VENTILADOR EN EL INTERIOR DEL LOCAL ACONDICIONADO O DEL CIRCUITO DE AIRE *****	10	1,32	0,88	0,66	0,53	0,44	2,70	1,80	1,35	1,08	0,90
	15	2,67	1,78	1,33	1,07	0,89	3,66	2,44	1,88	1,46	1,22
	20	3,30	2,20	1,65	1,32	1,10	3,84	2,56	1,92	1,54	1,28
	30	5,00	2,34	2,50	2,00	1,67	7,65	5,10	3,82	3,05	2,55
	40	6,66	4,44	3,33	2,66	2,22	10,32	6,88	5,16	4,12	3,44
	50	9,00	6,00	4,50	3,60	3,00	13,50	9,00	6,75	5,40	4,50
	60	10,68	7,12	5,34	4,30	3,56	16,65	11,00	8,32	6,65	5,55
	80	15,60	10,40	7,80	6,25	5,20	23,40	15,60	11,70	9,50	7,80
	100	20,10	13,40	10,00	8,05	6,70					
	125	26,70	17,80	13,35	10,07	8,90					
	150	33,30	22,20	16,65	13,30	11,10					
	200	50,40	33,60	25,20	20,00	16,80					

- * Estos valores tienen en cuenta que una parte de la energía aplicada al ventilador se disipa en la sala de máquinas.
- ** La altura manométrica total debe tener en cuenta la presión dinámica en la impulsión, si la velocidad correspondiente es mayor que 6 m/seg.
- *** El rendimiento del ventilador se toma igual al 70 %.
- **** El rendimiento del ventilador se toma igual al 50 %.
- ***** El rendimiento de la transmisión se toma igual al 80 %.
- ***** Si el ventilador está situado detrás de las baterías, estas ganancias son comunicadas al aire insuflado y se suman a las ganancias sensibles del local. Si el ventilador está situado delante de las baterías, estas ganancias se suman al balance frigorífico total de la instalación.

Anexo 27. Ganancias debidas al Ventilador de Insuflación.

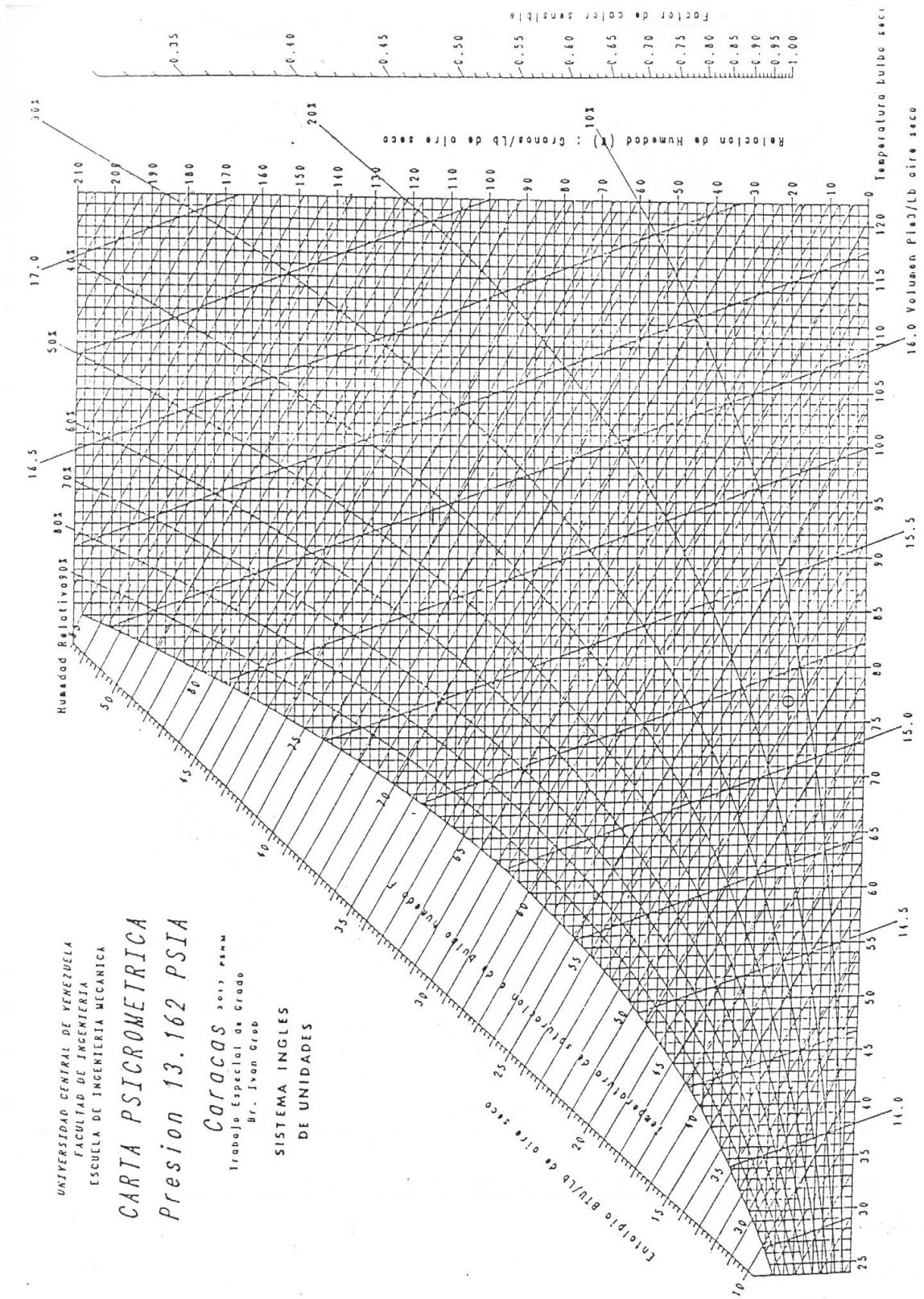

Anexo 28. Carta Psicrométrica para la Ciudad de Caracas.

GANANCIAS DEBIDAS AL CALENTAMIENTO DE LOS CONDUCTOS DE INSUFLACIÓN
Expresadas en porcentaje de las ganancias sensibles del local

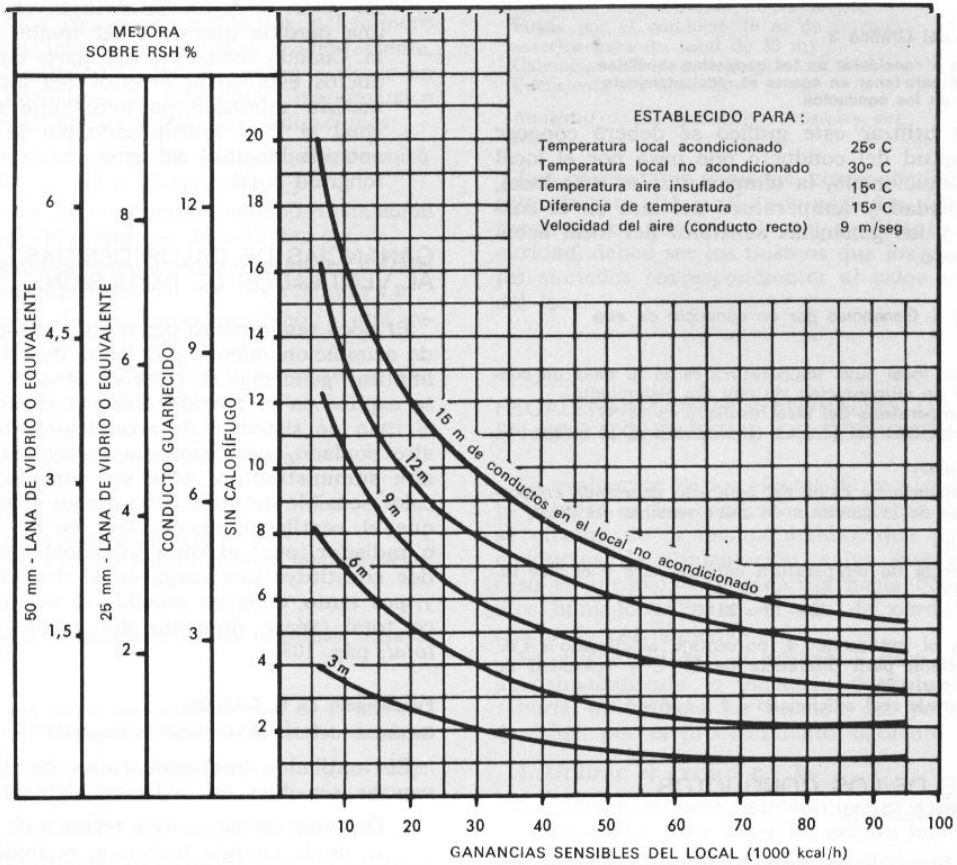

Anexo 29. Ganancias debidas al Calentamiento de los Conductos de Insuflación.

COEFICIENTES DE CORRECCIÓN
PARA DIFERENTES VALORES DE LA VELOCIDAD
DEL AIRE Y DE LA DIFERENCIA DE TEMPERATURA

Diferencia de temperatura °C	Velocidad en el conducto (m/seg)					
	5	8	9	10	15	20
10	0,90	0,74	0,68	0,64	0,55	0,45
15	1,34	1,08	1,00	0,96	0,82	0,67
20	1,80	1,43	1,33	1,27	1,09	0,89
25	2,23	1,78	1,67	1,58	1,36	1,11
30	2,69	2,12	2,00	1,89	1,63	1,33

Anexo 30. Coeficientes de Corrección para Diferentes Valores de la Velocidad del Aire y de la Diferencia de Temperatura.

COEFICIENTE DE CORRECCIÓN PARA DIFERENTES VALORES DE LA TEMPERATURA EN EL LOCAL ACONDICIONADO

Temperatura interior (°C)	Coficiente
24	0,946
24° 5	0,972
25	1,000
25° 5	1,028
26	1,055
26° 5	1,082
27	1,110

Anexo 31. Coeficiente de Corrección para Diferentes Valores de la Temperatura en el Local Acondicionado.

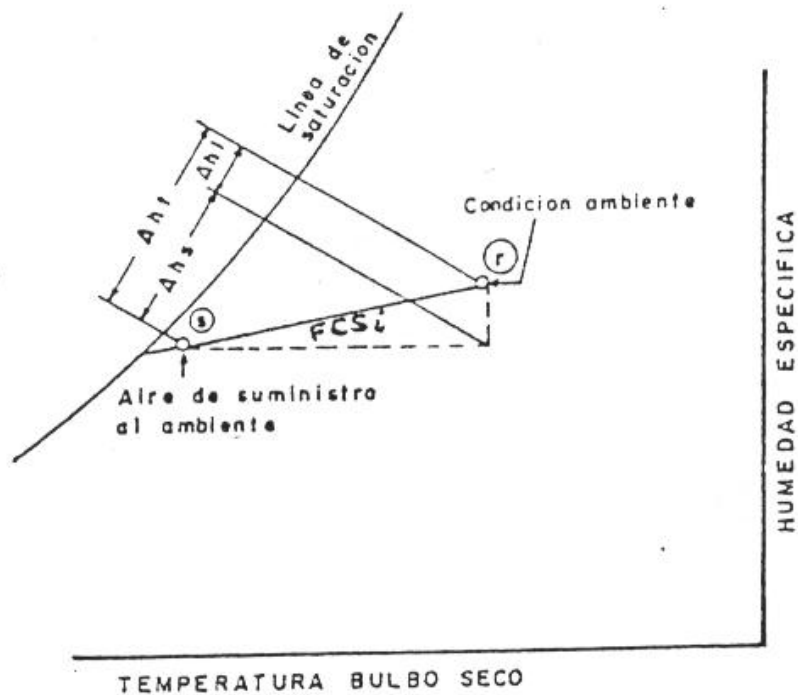

Anexo 32. Línea de Factor de Calor Sensible Interno.

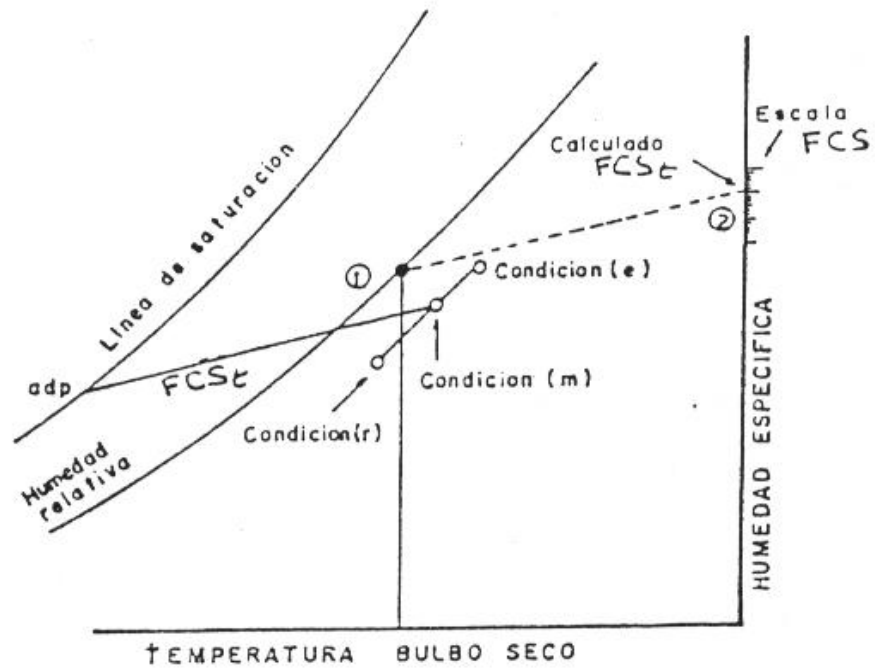

Anexo 35. Procedimiento para el Trazado de la Línea de Factor de Calor Sensible Total.

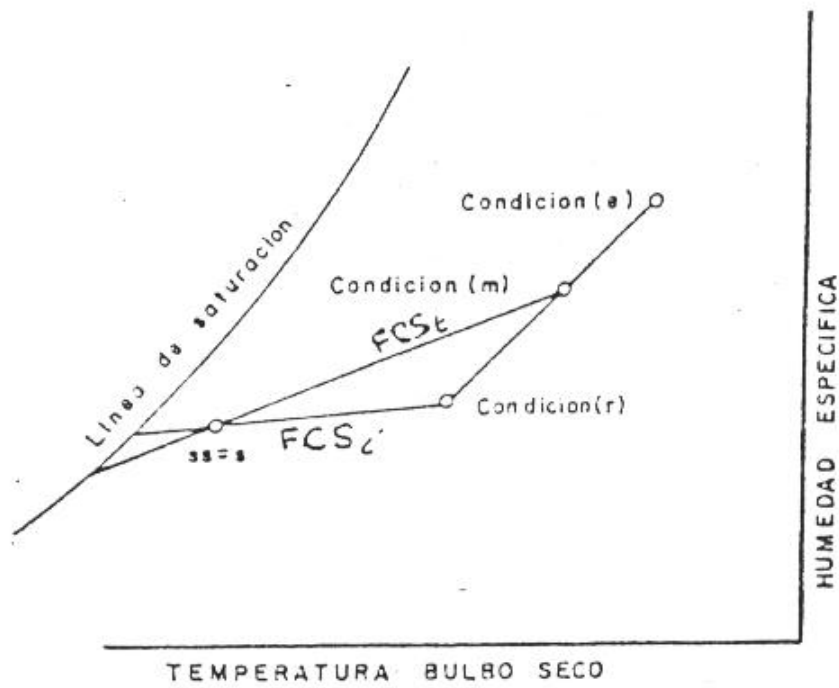

Anexo 36. Líneas de Factor de Calor Sensible Interno y Total.

Lado (pulg)	6	7	8	9	10	11	12	13	14	15	16	17	18	19	20	21	22	23	24	25	26	27	28	29	30	
6	6.6																									
7	7.1	7.7																								
8	7.6	8.2	8.7																							
9	8.0	8.7	9.3	9.8																						
10	8.4	9.1	9.8	10.4	10.9																					
11	8.8	9.5	10.2	10.9	11.5	12.0																				
12	9.1	9.9	10.7	11.3	12.0	12.6	13.1																			
13	9.5	10.3	11.1	11.8	12.4	13.1	13.7	14.2																		
14	9.8	10.7	11.5	12.2	12.9	13.5	14.2	14.7	15.3																	
15	10.1	11.0	11.8	12.6	13.3	14.0	14.6	15.3	15.8	16.4																
16	10.4	11.3	12.2	13.0	13.7	14.4	15.1	15.7	16.4	16.9	17.5															
17	10.7	11.6	12.5	13.4	14.1	14.9	15.6	16.2	16.8	17.4	18.0	18.6														
18	11.0	11.9	12.9	13.7	14.5	15.3	16.0	16.7	17.3	17.9	18.5	19.1	19.7													
19	11.2	12.2	13.2	14.1	14.9	15.7	16.4	17.1	17.8	18.4	19.0	19.6	20.2	20.8												
20	11.5	12.5	13.5	14.4	15.2	16.0	16.8	17.5	18.2	18.9	19.5	20.1	20.7	21.3	21.9											
21	11.7	12.8	13.8	14.7	15.6	16.4	17.2	17.9	18.6	19.3	20.0	20.6	21.2	21.8	22.4	23.0										
22	12.0	13.0	14.1	15.0	15.9	16.8	17.6	18.3	19.1	19.8	20.4	21.1	21.7	22.3	22.9	23.5	24.0									
23	12.2	13.3	14.3	15.3	16.2	17.1	17.9	18.7	19.5	20.2	20.9	21.5	22.2	22.8	23.4	24.0	24.6	25.1								
24	12.4	13.5	14.6	15.6	16.5	17.4	18.3	19.1	19.9	20.6	21.3	22.0	22.7	23.3	23.9	24.5	25.1	25.7	26.2							
25	12.6	13.8	14.9	15.9	16.8	17.8	18.6	19.4	20.2	21.0	21.7	22.4	23.1	23.8	24.4	25.0	25.6	26.2	26.8	27.3						
26	12.8	14.0	15.1	16.2	17.1	18.1	19.0	19.8	20.6	21.4	22.1	22.9	23.5	24.2	24.9	25.5	26.1	26.7	27.3	27.9	28.4					
27	13.0	14.2	15.4	16.4	17.4	18.4	19.3	20.1	21.0	21.8	22.5	23.3	24.0	24.7	25.3	26.0	26.6	27.2	27.8	28.4	29.0	29.5				
28	13.2	14.5	15.6	16.7	17.7	18.7	19.6	20.5	21.3	22.1	22.9	23.7	24.4	25.1	25.8	26.4	27.1	27.7	28.3	28.9	29.5	30.1	30.6			
29	13.4	14.7	15.9	17.0	18.0	19.0	19.9	20.8	21.7	22.5	23.3	24.1	24.8	25.5	26.2	26.9	27.5	28.2	28.8	29.4	30.0	30.6	31.1	31.7		
30	13.6	14.9	16.1	17.2	18.3	19.3	20.2	21.1	22.0	22.9	23.7	24.4	25.2	25.9	26.6	27.3	28.0	28.6	29.3	29.9	30.5	31.1	31.7	32.2	32.8	
31	13.8	15.1	16.3	17.4	18.5	19.5	20.5	21.4	22.3	23.2	24.0	24.8	25.6	26.3	27.1	27.8	28.4	29.1	29.8	30.4	31.0	31.6	32.2	32.8	33.3	
32	14.0	15.3	16.5	17.7	18.8	19.8	20.8	21.8	22.7	23.5	24.4	25.2	26.0	26.7	27.5	28.2	28.9	29.6	30.2	30.9	31.5	32.1	32.7	33.3	33.9	
33	14.2	15.5	16.8	17.9	19.0	20.1	21.1	22.1	23.0	23.9	24.7	25.5	26.3	27.1	27.9	28.6	29.3	30.0	30.7	31.3	32.0	32.6	33.2	33.8	34.4	
34	14.4	15.7	17.0	18.2	19.3	20.4	21.4	22.4	23.3	24.2	25.1	25.9	26.7	27.5	28.3	29.0	29.7	30.4	31.0	31.8	32.4	33.1	33.7	34.3	34.9	
35	14.5	15.9	17.2	18.4	19.5	20.6	21.6	22.6	23.6	24.5	25.4	26.2	27.1	27.9	28.6	29.4	30.1	30.8	31.5	32.2	32.9	33.5	34.2	34.8	35.4	
36	14.7	16.1	17.4	18.6	19.8	20.9	21.9	22.9	23.9	24.8	25.7	26.6	27.4	28.2	29.0	29.8	30.5	31.3	32.0	32.7	33.3	34.0	34.6	35.3	35.9	
37	14.9	16.3	17.6	18.8	20.0	21.1	22.2	23.2	24.2	25.1	26.0	26.9	27.8	28.6	29.4	30.2	30.9	31.7	32.4	33.1	33.8	34.4	35.1	35.7	36.4	
38	15.0	16.5	17.8	19.0	20.2	21.4	22.4	23.5	24.5	25.4	26.4	27.2	28.1	28.9	29.8	30.5	31.3	32.1	32.8	33.5	34.2	34.9	35.6	36.2	36.8	
39	15.2	16.6	18.0	19.2	20.4	21.6	22.7	23.7	24.7	25.7	26.7	27.6	28.4	29.3	30.1	30.9	31.7	32.5	33.2	33.9	34.6	35.3	36.0	36.7	37.3	
40	15.3	16.8	18.2	19.5	20.7	21.8	22.9	24.0	25.0	26.0	27.0	27.9	28.8	29.6	30.5	31.3	32.1	32.8	33.6	34.3	35.1	35.7	36.4	37.1	37.8	

Anexo 39. Diámetro Circular Equivalente para Ductos Rectangulares (Pulgadas).

QUIRÓFANOS	ANCHO (m)	LARGO (m)
Sala de Parto	0,25	0,45
AA	0,25 metros de diámetro	
A	0,30	0,80
B	0,30	0,80
C	0,30	0,80
D	0,15	0,25
	0,30	0,40
E	0,30	0,80
F	0,30	0,80
G	0,30	0,80
H	0,20	0,65
I	0,30	0,80
J	0,20	0,60
K	0,25	0,65
	0,25	0,55
L	0,25	0,65
LL	0,30	0,45
M	0,20	0,65
	0,20	0,65
N	0,20	0,65
	0,20	0,65
Ñ	0,30	0,90
O	0,20	0,65
P	0,15	0,35
	0,15	0,35

Anexo 40. Dimensiones de las Rejillas de Suministro en Cada uno de los Quirófanos.

**Ecuación para el Cálculo de los Cambios de Aire por Hora
Conociendo las Dimensiones de las Rejillas de Suministro.**

$$CAPH = (V_a \times (3.600 \text{ seg/hr}) \times A) / V_{\text{esp.}}$$

Siendo:

CAPH : cambios de aire por hora.

V_a : velocidad del aire en la rejilla de suministro; m/s.

A : área de la rejilla de suministro; m².

$V_{\text{esp.}}$: volumen del espacio a ser acondicionado; m³.

ÁREA		Promedio de Bacterias por m ³ (ft ³)	Rango de Bacterias por m ³ (ft ³)
Cirugía (en uso)	Corredores.	918 (26)	141–4.589 (4–130)
	Quirófano.	353 (10)	35–2.824 (1–80)
	Cuarto de Cepillado e Inducción.	565 (16)	71–2.153 (2–61)

Anexo 41. Promedio de Bacterias por m³ en un Hospital en U.S.A.

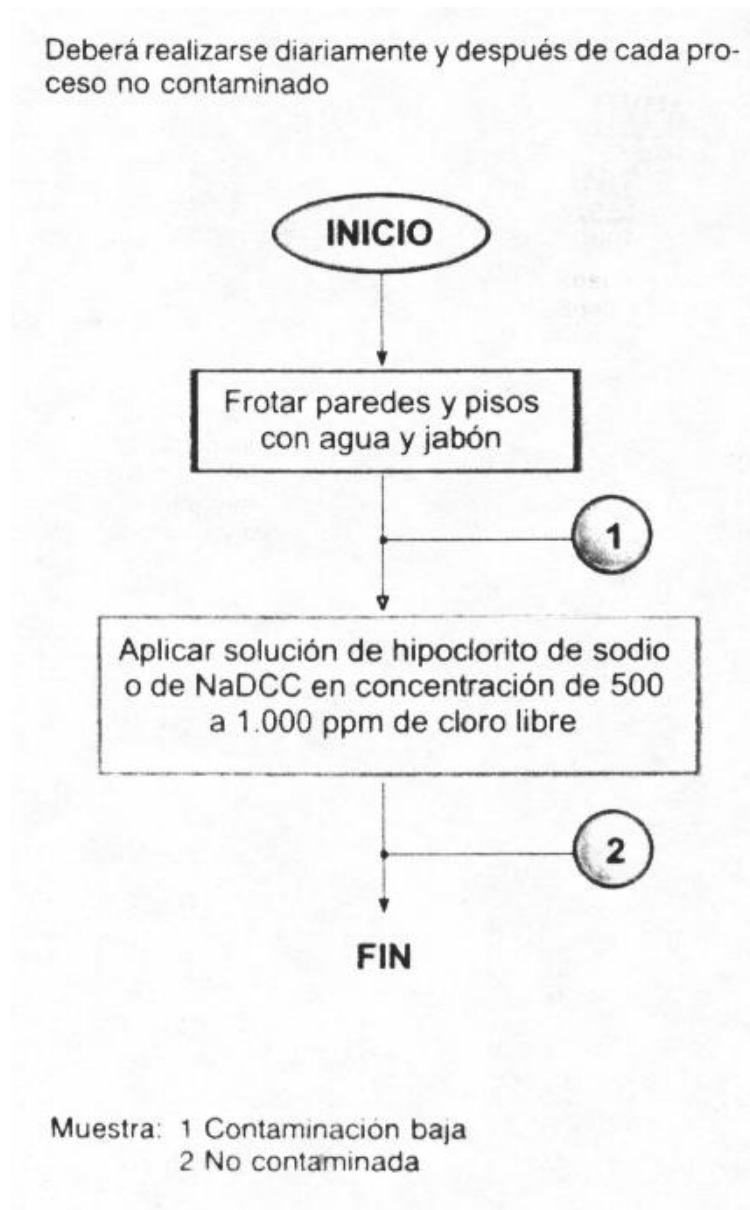

Anexo 42. Lavado Rutinario de Áreas Críticas.

Deberá efectuarse: Después de cada proceso séptico
 En caso de brote infeccioso
 Cada ocho días

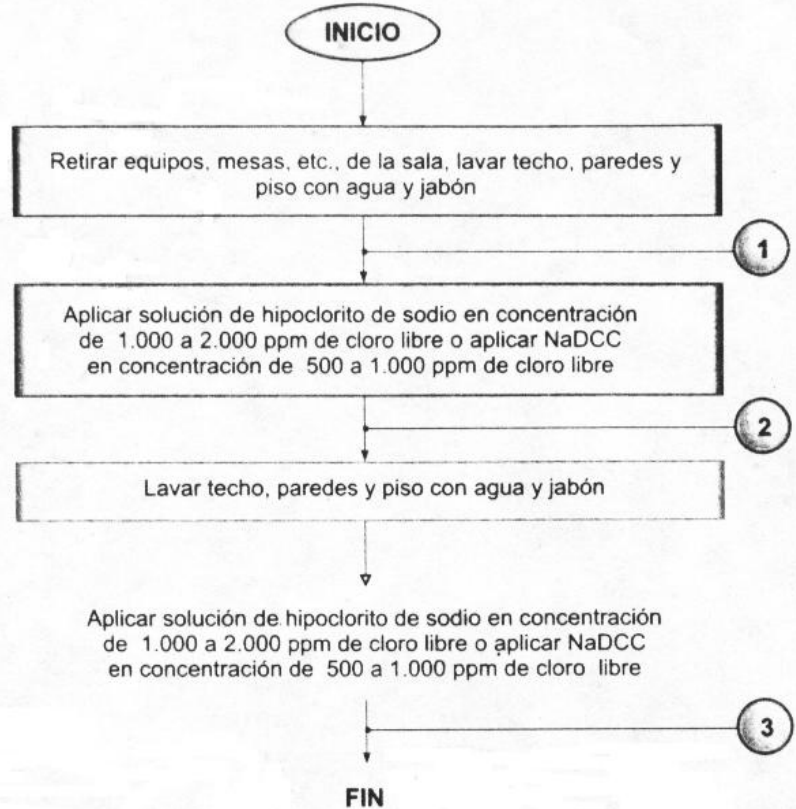

No. Muestra	Resultado
1	Contaminada
2	Contaminación baja
3	No contaminada

Estos lavados incluyen, salas de cirugía, salas de parto, salas de pacientes, baño pacientes, pasillos y corredores de las unidades de cirugía y materno infantil, etc.

Anexo 43. Lavado Terminal de Áreas Críticas.

```

*****
*****
***
***          L O A D   D E S I G N   A N A L Y S I S          ***
***
***          by HENRY ALFONZO          ***
***
*****
*****

```

PISO 4

```

Weather File Code:          CARACAS
  Location:                 CARACAS, DISTRITO FEDERAL
  Created by:               Trane Co.
Latitude:                   10.5 deg
Longitude:                  66.9 deg
Time Zone:                  4
Elevation:                  2900

Summer Clearness No:       1.00
Winter Clearness No:       1.00
Summer Design Dry Bulb:    88
Summer Design Wet Bulb:    0
Winter Design Dry Bulb:    62

Summer Ground Reflect      .20
Winter Ground Reflect      .20

```

```

Cooling Months Simulated:  Jan through Dec
Cooling Load Method 2: 1985 ASHRAE CLTD/CLF (TFM)

```

```

Time/Date Program Run:      7:31:43    11/11/ 3
Dataset Name:               HOSPITA1

```

Anexo 44. Análisis de Cargas Térmicas.

***** CUSTOMER DIRECT SERVICE NETWORK *****
 For exclusive use by: HENRY ALFONZO

V 6.08
 PAGE 1

S Y S T E M S U M M A R Y

Syst #	VTCV	-----Air Quantities-----				-----Heating Mbh-----			
		OACfm	Cooling	Heating	Tons	Extrnl	Vent	Reheat	Total
1	VTCV	12295	12295	0	60.9	.0	.0	.0	.0
2	VTCV	11885	11885	0	59.0	.0	.0	.0	.0
3	VTCV	645	8869	0	17.1	.0	.0	.0	.0
4	VTCV	1235	6822	0	14.5	.0	.0	.0	.0
5	VTCV	2980	2980	0	14.8	.0	.0	.0	.0
Totals		29040	42851	0	166.3	.0	.0	.0	.0

The building peaked at hour 15 month 7 with a capacity of 166.1 tons

***** E N G I N E E R I N G C H E C K S *****

* Syst #	% OA	-----Cooling-----				-----Heating-----		Floor Sq Ft
		Cfm/ Sq Ft	Cfm/ Ton	Sq Ft /Ton	Btuh /Sq Ft	Cfm /Sq Ft	Btuh /Sq Ft	
* 1	VTCV100.0	3.61	201.7	55.9	214.50	.00	.00	3409
* 2	VTCV100.0	3.47	201.6	58.1	206.57	.00	.00	3424
* 3	VTCV 7.3	1.10	518.3	471.8	25.43	.00	.00	8073
* 4	VTCV 18.1	1.01	471.8	465.5	25.78	.00	.00	6731
* 5	VTCV100.0	3.27	201.4	61.6	194.95	.00	.00	910
* Av/Tot	67.8	1.90	257.7	135.6	88.49	.00	.00	22547

Z O N E S U M M A R Y

Zone #	Description	-----Cooling-----				-----Heating-----			
		ZnCfm	SADB	Sqft	Coil Mbh	ZnCfm	SADB	Sqft	Total Mbh
100	QUIROFANO A-A	1005	67.1	3.99	59.7	0	.0	.00	.0
102	QUIROFANO A	1500	66.9	3.26	89.4	0	.0	.00	.0
104	QUIROFANO B	1340	67.0	3.29	79.8	0	.0	.00	.0
106	QUIROFANO C	1280	67.0	3.46	76.2	0	.0	.00	.0
108	QUIROFANO D	1115	67.1	4.01	66.2	0	.0	.00	.0
110	WUIROFANO E	1340	67.0	3.29	79.8	0	.0	.00	.0
112	QUIROFANO F	1195	67.1	3.68	71.1	0	.0	.00	.0
114	QUIROFANO G	1195	67.1	3.68	71.1	0	.0	.00	.0
116	QUIROFANO H	500	66.9	3.04	29.8	0	.0	.00	.0
118	DEPOSITO	630	67.5	6.45	37.2	0	.0	.00	.0
120	QUIROFANO I	1195	67.1	3.68	71.1	0	.0	.00	.0
Sys 1	Totals ----->	12295			731.4	0			.0
200	QUIROFANO N-	1370	67.0	3.37	81.6	0	.0	.00	.0
202	QUIROFANO N CARD	1245	67.1	3.66	74.0	0	.0	.00	.0
204	DEP. QUIF. H	315	66.3	1.98	19.0	0	.0	.00	.0
206	QUIROPFANO M	1370	67.0	3.37	81.6	0	.0	.00	.0
208	QUIROFANO LL	1370	67.0	3.37	81.6	0	.0	.00	.0
210	DEP QUROFANOS	315	66.3	1.98	19.0	0	.0	.00	.0
212	QUIROFANO L'	1235	67.1	3.72	73.4	0	.0	.00	.0
214	QUIROFANO K	1540	67.0	3.58	91.6	0	.0	.00	.0
216	QUIROFANO J	1100	67.2	4.05	65.3	0	.0	.00	.0
218	QUIROFANO O	1000	67.2	4.04	59.4	0	.0	.00	.0
220	QUIROFANO P	1025	67.1	3.88	60.9	0	.0	.00	.0
Sys 2	Totals ----->	11885			707.4	0			.0

***** CUSTOMER DIRECT SERVICE NETWORK *****
 For exclusive use by: HENRY ALFONZO

V 6.08
 PAGE 2

Z O N E S U M M A R Y

Zone #	Description	-----Cooling-----				-----Heating-----			Total Mbh
		ZnCfm	SADB	Cfm/Sqft	Coil Mbh	ZnCfm	SADB	Cfm/Sqft	
288	MATERIA ANESTECI	462	56.5	1.81	10.6	0	.0	.00	.0
290	CENTRAL ANESTECI	433	56.5	1.55	11.0	0	.0	.00	.0
292	.5 PASILLO SUR	291	56.5	.67	5.6	0	.0	.00	.0
294	PASILLO N-S	232	56.5	.67	4.4	0	.0	.00	.0
296	PASILLO NORTE	282	56.5	.67	5.4	0	.0	.00	.0
298	PASILLO	1046	56.5	.67	20.0	0	.0	.00	.0
300	PRE ANESTECIA	1959	56.5	1.73	45.6	0	.0	.00	.0
302	DEPOSITO	103	56.5	.97	2.9	0	.0	.00	.0
304	DEPOSITO	148	56.5	.94	3.7	0	.0	.00	.0
306	DEP. ESTERILIZAC	508	56.5	.90	11.5	0	.0	.00	.0
308	AUTO CLAVE	211	56.5	1.11	4.9	0	.0	.00	.0
310	FAENA LIMPIA	584	56.5	.92	13.8	0	.0	.00	.0
312	RAYOS X	112	56.5	.96	3.1	0	.0	.00	.0
314	DEPOSITO	71	56.5	1.05	2.3	0	.0	.00	.0
316	FAENA SUCIA	393	56.5	.92	9.3	0	.0	.00	.0
318	RECUPERACION 1	1721	56.5	1.54	43.6	0	.0	.00	.0
320	DEPOSITO	126	56.5	.96	3.3	0	.0	.00	.0
322	DEPOSITO	178	56.5	1.28	4.3	0	.0	.00	.0
Sys 3	Totals ----->	8860			205.3	0			.0
324	RECUPERACION 2	1174	58.1	1.45	27.1	0	.0	.00	.0
326	CUSRTO LIMPIEZA	88	58.1	1.12	2.4	0	.0	.00	.0
328	CENTRAL SUMINIST	128	58.1	1.05	3.1	0	.0	.00	.0
330	ESTAR	254	58.1	1.21	7.9	0	.0	.00	.0
332	DEPOSITO	80	58.1	1.14	2.3	0	.0	.00	.0
334	SUPERVISOR	190	58.1	1.10	5.1	0	.0	.00	.0
336	ANTESALA	95	58.1	1.10	2.5	0	.0	.00	.0
338	NEUROCIRUGIA	397	58.1	1.21	10.4	0	.0	.00	.0
340	CUSRTO REVELADO	170	67.5	1.98	9.2	0	.0	.00	.0
342	DEP. ANESTECIA	600	67.7	1.97	32.1	0	.0	.00	.0
344	SEPTICO	277	58.1	1.04	6.6	0	.0	.00	.0
346	DEPOSITO	141	58.1	1.04	3.3	0	.0	.00	.0
350	PASILLO A	1144	58.1	.73	20.1	0	.0	.00	.0
352	PASILLO CENTRAL	1144	58.1	.73	20.1	0	.0	.00	.0
354	PASILLO SUR	217	58.1	.73	3.8	0	.0	.00	.0
356	PASILLO NORTE	308	58.1	.73	5.4	0	.0	.00	.0
358	ESTAR ENFERMERAS	406	58.1	1.74	12.2	0	.0	.00	.0
Sys 4	Totals ----->	6813			173.5	0			.0
360	SALA DE PARTO	2980	67.0	3.27	177.6	0	.0	.00	.0
Sys 5	Totals ----->	2980			177.6	0			.0

***** CUSTOMER DIRECT SERVICE NETWORK *****
 For exclusive use by: HENRY ALFONZO

V 6.08
 PAGE 3

P E A K S P A C E C L G L O A D S								
Zone		Time	OA	-----Zone Totals-----				
#	Description	Mo/Hr	Condition	Room	Sens & Lat	Btuh/ Sq Ft	Space Sens	Total Latent
100	QUIROFANO A-A	8/15	88/74/123	68	59693	237.0	859	37482
102	QUIROFANO A	8/15	88/74/123	68	89381	194.3	1570	55944
104	QUIROFANO B	8/15	88/74/123	68	79834	196.1	1389	49976
106	QUIROFANO C	8/15	88/74/123	68	76196	205.8	1263	47739
108	QUIROFANO D	8/15	88/74/123	68	66222	238.0	949	41585
110	WUIROFANO E	8/15	88/74/123	68	79834	196.1	1389	49976
112	QUIROFANO F	8/15	88/74/123	68	71063	219.1	1106	44568
114	QUIROFANO G	8/15	88/74/123	68	71063	219.1	1106	44568
116	QUIROFANO H	8/15	88/74/123	68	29831	181.4	561	18648
118	DEPOSITO	8/15	88/74/123	68	37214	380.7	333	23496
120	QUIROFANO I	8/15	88/74/123	68	71063	219.1	1106	44568
Sys 1	Sum-of-the-Peaks		Totals/Averages-->		731397	214.5	11637	458555
	Block VTCV	8/15	88/74/123	68	731397	214.5	11637	458555
200	QUIROFANO N-	8/15	88/74/123	68	81590	200.4	1389	51095
202	QUIROFANO H CARD	8/15	88/74/123	68	74045	217.5	1161	46433
204	DEP. QUIF. H	8/15	88/74/123	68	18982	119.6	541	11748
206	QUIROFANO M	8/15	88/74/123	68	81590	200.4	1389	51095
208	QUIROFANO LL	8/15	88/74/123	68	81590	200.4	1389	51095
210	DEP QUROFANOS	8/15	88/74/123	68	18982	119.6	541	11748
212	QUIROFANO L	8/15	88/74/123	68	73430	221.3	1132	46060
214	QUIROFANO K	8/15	88/74/123	68	91620	213.0	1467	57435
216	QUIROFANO J	8/15	88/74/123	68	65321	240.7	926	41025
218	QUIROFANO O	8/15	88/74/123	68	59386	239.7	845	37296
220	QUIROFANO P	8/15	88/74/123	68	60907	230.3	902	38228
Sys 2	Sum-of-the-Peaks		Totals/Averages-->		707447	206.6	11689	443264
	Block VTCV	8/15	88/74/123	68	707447	206.6	11689	443264
288	MATERIA ANESTECI	8/17	86/74/123	75	10632	41.6	8520	1480
290	CENTRAL ANESTECI	8/17	86/74/123	75	10982	39.4	7985	2220
292	.5 PASILLO SUR	8/ 3	71/70/123	75	5562	12.8	5371	0
294	PASILLO N-S	8/ 3	71/70/123	75	4440	12.8	4288	0
296	PASILLO NORTE	8/ 3	71/70/123	75	5393	12.8	5208	0
298	PASILLO	8/ 3	71/70/123	75	19987	12.8	19300	0
300	PRE ANESTECIA	12/16	79/70/111	75	45625	40.4	36134	7487
302	DEPOSITO	8/ 3	71/70/123	75	2665	25.2	1917	740
304	DEPOSITO	8/ 3	71/70/123	75	3521	22.3	2743	740
306	DEP. ESTERILIZAC	8/ 3	71/70/123	75	11067	19.7	9373	1480
308	AUTO CLAVE	8/ 3	71/70/123	75	4712	24.8	3893	740
310	FAENA LIMPIA	8/ 3	71/70/123	75	13210	20.8	10786	2220
312	RAYOS X	8/ 3	71/70/123	75	2834	24.4	2080	740
314	DEPOSITO	8/ 3	71/70/123	75	2040	30.2	1313	740
316	FAENA SUCIA	8/ 3	71/70/123	75	8878	20.7	7259	1480
318	RECUPERACION 1	6/17	85/73/124	75	43621	39.1	31747	8951
320	DEPOSITO	8/ 3	71/70/123	75	3087	23.5	2324	740
322	DEPOSITO	6/19	81/72/124	75	4243	30.5	3290	745
Sys 3	Sum-of-the-Peaks		Totals/Averages-->		202509	25.1	163539	30508
	Block VTCV	6/17	85/73/124	75	196784	24.4	152464	32077
324	RECUPERACION 2	6/19	81/72/124	75	26780	33.2	19811	5481

***** CUSTOMER DIRECT SERVICE NETWORK *****

V 6.08

For exclusive use by: HENRY ALFONZO

PAGE 4

Zone #	Description	Time of Pk Mo/Hr	OA Condition DB/WB/OAW	Room DB	-----Zone Totals-----			
					Sens & Lat	Btuh/ Sq Ft	Space Sens	Total Latent
326	CUSRTO LIMPIEZA	8/ 3	71/70/123	75	2164	27.5	1487	679
328	CENTRAL SUMINIST	8/ 3	71/70/123	75	2870	23.6	2166	679
330	ESTAR	8/ 3	71/70/123	75	6942	33.1	4297	2717
332	DEPOSITO	8/ 3	71/70/123	75	2025	28.9	1353	679
334	SUPERVISOR	8/ 3	71/70/123	75	4580	26.6	3215	1358
336	ANTESALA	8/ 3	71/70/123	75	2290	26.6	1607	679
338	NEUROCIRUGIA	8/ 3	71/70/123	75	9443	28.9	6704	2717
340	CUSRTO REVELADO	8/15	88/74/123	75	9167	106.7	1271	5581
342	DEP. ANESTECIA	8/15	88/74/123	75	32134	105.4	4376	19590
344	SEPTICO	8/ 3	71/70/123	75	6109	23.0	4688	1358
346	DEPOSITO	8/ 3	71/70/123	75	3101	22.9	2389	679
350	PASILLO A	8/ 3	71/70/123	75	20051	12.9	19300	0
352	PASILLO CENTRAL	8/ 3	71/70/123	75	20051	12.9	19300	0
354	PASILLO SUR	8/ 3	71/70/123	75	3817	12.9	3674	0
356	PASILLO NORTE	8/ 3	71/70/123	75	5411	12.9	5208	0
358	ESTAR ENFERMERAS	8/11	81/72/123	75	11739	50.2	6858	4076
Sys 4	Sum-of-the-Peaks	Totals/Averages-->			168681	25.1	107712	46280
	Block VTCV	7/19	82/73/123	75	165645	24.6	106268	46287
360	SALA DE PARTO	8/15	88/74/123	68	177560	194.9	3108	111142
Sys 5	Sum-of-the-Peaks	Totals/Averages-->			177560	194.9	3108	111142
	Block VTCV	8/15	88/74/123	68	177560	194.9	3108	111142

-----Building Envelope-----									
Zone #	Roof Space Sens	Roof RA Sens	Roof CLTD	Skylt Solar Sens	Skylt Solar CLF	Skylt Cond Sens	Skylt Cond CLTD	Part Sens	Part CLTD
100	0	0	.0	0	.000	0	.0	0	.0
102	0	0	.0	0	.000	0	.0	0	.0
104	0	0	.0	0	.000	0	.0	0	.0
106	0	0	.0	0	.000	0	.0	0	.0
108	0	0	.0	0	.000	0	.0	0	.0
110	0	0	.0	0	.000	0	.0	0	.0
112	0	0	.0	0	.000	0	.0	0	.0
114	0	0	.0	0	.000	0	.0	0	.0
116	0	0	.0	0	.000	0	.0	0	.0
118	0	0	.0	0	.000	0	.0	0	.0
120	0	0	.0	0	.000	0	.0	0	.0
Pk 1	0	0	.0	0	.000	0	.0	0	.0
Bk 1	0	0	.0	0	.000	0	.0	0	.0
200	0	0	.0	0	.000	0	.0	0	.0
202	0	0	.0	0	.000	0	.0	0	.0
204	0	0	.0	0	.000	0	.0	0	.0
206	0	0	.0	0	.000	0	.0	0	.0
208	0	0	.0	0	.000	0	.0	0	.0
210	0	0	.0	0	.000	0	.0	0	.0
212	0	0	.0	0	.000	0	.0	0	.0
214	0	0	.0	0	.000	0	.0	0	.0
216	0	0	.0	0	.000	0	.0	0	.0
218	0	0	.0	0	.000	0	.0	0	.0

***** CUSTOMER DIRECT SERVICE NETWORK *****
 For exclusive use by: HENRY ALFONZO

V 6.08
 PAGE 5

-----Building Envelope-----									
Zone #	Roof Space Sens	Roof RA Sens	Roof CLTD	Skylt Solar Sens	Skylt Solar CLF	Skylt Cond Sens	Skylt Cond CLTD	Part Sens	Part CLTD
220	0	0	.0	0	.000	0	.0	0	.0
Pk 2	0	0	.0	0	.000	0	.0	0	.0
Bk 2	0	0	.0	0	.000	0	.0	0	.0
288	0	0	.0	0	.000	0	.0	0	.0
290	0	0	.0	0	.000	0	.0	0	.0
292	0	0	.0	0	.000	0	.0	0	.0
294	0	0	.0	0	.000	0	.0	0	.0
296	0	0	.0	0	.000	0	.0	0	.0
298	0	0	.0	0	.000	0	.0	0	.0
300	0	0	.0	0	.000	0	.0	0	.0
302	0	0	.0	0	.000	0	.0	0	.0
304	0	0	.0	0	.000	0	.0	0	.0
306	0	0	.0	0	.000	0	.0	0	.0
308	0	0	.0	0	.000	0	.0	0	.0
310	0	0	.0	0	.000	0	.0	0	.0
312	0	0	.0	0	.000	0	.0	0	.0
314	0	0	.0	0	.000	0	.0	0	.0
316	0	0	.0	0	.000	0	.0	0	.0
318	0	0	.0	0	.000	0	.0	0	.0
320	0	0	.0	0	.000	0	.0	0	.0
322	0	0	.0	0	.000	0	.0	0	.0
Pk 3	0	0	.0	0	.000	0	.0	0	.0
Bk 3	0	0	.0	0	.000	0	.0	0	.0
324	0	0	.0	0	.000	0	.0	0	.0
326	0	0	.0	0	.000	0	.0	0	.0
328	0	0	.0	0	.000	0	.0	0	.0
330	0	0	.0	0	.000	0	.0	0	.0
332	0	0	.0	0	.000	0	.0	0	.0
334	0	0	.0	0	.000	0	.0	0	.0
336	0	0	.0	0	.000	0	.0	0	.0
338	0	0	.0	0	.000	0	.0	0	.0
340	0	0	.0	0	.000	0	.0	0	.0
342	0	0	.0	0	.000	0	.0	0	.0
344	0	0	.0	0	.000	0	.0	0	.0
346	0	0	.0	0	.000	0	.0	0	.0
350	0	0	.0	0	.000	0	.0	0	.0
352	0	0	.0	0	.000	0	.0	0	.0
354	0	0	.0	0	.000	0	.0	0	.0
356	0	0	.0	0	.000	0	.0	0	.0
358	0	0	.0	0	.000	0	.0	0	.0
Pk 4	0	0	.0	0	.000	0	.0	0	.0
Bk 4	0	0	.0	0	.000	0	.0	0	.0
360	0	0	.0	0	.000	0	.0	0	.0
Pk 5	0	0	.0	0	.000	0	.0	0	.0
Bk 5	0	0	.0	0	.000	0	.0	0	.0

-----Building Envelope-----									
Zone #	Wall Space Sens	Wall RA Sens	Wall CLTD	Glass Solar Sens	Glass Solar CLF	Glass Cond Sens	Glass Cond CLTD	Xflr Sens	Xflr CLTD
100	0	0	.0	0	.000	0	.0	0	.0

***** CUSTOMER DIRECT SERVICE NETWORK *****
 For exclusive use by: HENRY ALFONZO

V 6.08
 PAGE 6

-----Building Envelope-----									
Zone #	Wall Space Sens	Wall RA Sens	Wall CLTD	Glass Solar Sens	Glass Solar CLF	Glass Cond Sens	Glass Cond CLTD	Xflr Sens	Xflr CLTD
102	0	0	.0	0	.000	0	.0	0	.0
104	0	0	.0	0	.000	0	.0	0	.0
106	0	0	.0	0	.000	0	.0	0	.0
108	0	0	.0	0	.000	0	.0	0	.0
110	0	0	.0	0	.000	0	.0	0	.0
112	0	0	.0	0	.000	0	.0	0	.0
114	0	0	.0	0	.000	0	.0	0	.0
116	0	0	.0	0	.000	0	.0	0	.0
118	0	0	.0	0	.000	0	.0	0	.0
120	0	0	.0	0	.000	0	.0	0	.0
Pk 1	0	0	.0	0	.000	0	.0	0	.0
Bk 1	0	0	.0	0	.000	0	.0	0	.0
200	0	0	.0	0	.000	0	.0	0	.0
202	0	0	.0	0	.000	0	.0	0	.0
204	0	0	.0	0	.000	0	.0	0	.0
206	0	0	.0	0	.000	0	.0	0	.0
208	0	0	.0	0	.000	0	.0	0	.0
210	0	0	.0	0	.000	0	.0	0	.0
212	0	0	.0	0	.000	0	.0	0	.0
214	0	0	.0	0	.000	0	.0	0	.0
216	0	0	.0	0	.000	0	.0	0	.0
218	0	0	.0	0	.000	0	.0	0	.0
220	0	0	.0	0	.000	0	.0	0	.0
Pk 2	0	0	.0	0	.000	0	.0	0	.0
Bk 2	0	0	.0	0	.000	0	.0	0	.0
288	597	0	26.0	3079	.508	363	7.0	64	2.0
290	499	0	26.0	2148	.510	254	7.0	62	2.0
292	0	0	.0	0	.000	0	.0	192	3.6
294	0	0	.0	0	.000	0	.0	154	3.6
296	0	0	.0	0	.000	0	.0	187	3.6
298	0	0	.0	0	.000	0	.0	693	3.6
300	2477	0	37.3	12462	.635	-231	-1.2	-804	-5.7
302	0	0	.0	0	.000	0	.0	46	3.6
304	0	0	.0	0	.000	0	.0	70	3.6
306	0	0	.0	0	.000	0	.0	250	3.6
308	0	0	.0	0	.000	0	.0	84	3.6
310	0	0	.0	0	.000	0	.0	283	3.6
312	0	0	.0	0	.000	0	.0	51	3.6
314	0	0	.0	0	.000	0	.0	29	3.6
316	0	0	.0	0	.000	0	.0	190	3.6
318	2003	0	30.1	6345	.765	1197	6.3	214	1.5
320	0	0	.0	0	.000	0	.0	58	3.6
322	843	0	33.2	25	.524	6	5.5	32	1.8
Pk 3	6422	0	32.0	24060	.629	1590	3.4	1863	1.9
Bk 3	4700	0	23.4	13660	.624	2956	6.3	1544	1.5
324	3829	0	30.5	45	.271	12	5.6	186	1.8
326	0	0	.0	0	.000	0	.0	34	3.6
328	0	0	.0	0	.000	0	.0	53	3.6
330	0	0	.0	0	.000	0	.0	93	3.6

***** CUSTOMER DIRECT SERVICE NETWORK *****
 For exclusive use by: HENRY ALFONZO

V 6.08
 PAGE 7

-----Building Envelope-----

Zone #	Wall Space Sens	Wall RA Sens	Wall CLTD	Glass Solar Sens	Glass Solar CLF	Glass Cond Sens	Glass Cond CLTD	Xflr Sens	Xflr CLTD
332	0	0	.0	0	.000	0	.0	31	3.6
334	0	0	.0	0	.000	0	.0	76	3.6
336	0	0	.0	0	.000	0	.0	38	3.6
338	0	0	.0	0	.000	0	.0	145	3.6
340	0	0	.0	0	.000	0	.0	0	.0
342	0	0	.0	0	.000	0	.0	0	.0
344	0	0	.0	0	.000	0	.0	118	3.6
346	0	0	.0	0	.000	0	.0	60	3.6
350	0	0	.0	0	.000	0	.0	693	3.6
352	0	0	.0	0	.000	0	.0	693	3.6
354	0	0	.0	0	.000	0	.0	131	3.6
356	0	0	.0	0	.000	0	.0	187	3.6
358	290	0	19.5	1390	.440	47	1.3	70	2.4
Pk 4	4120	0	29.3	1436	.431	59	1.6	2615	3.3
Bk 4	4117	0	29.3	558	.176	252	6.6	1858	2.3
360	0	0	.0	0	.000	0	.0	0	.0
Pk 5	0	0	.0	0	.000	0	.0	0	.0
Bk 5	0	0	.0	0	.000	0	.0	0	.0

-----Internal Loads-----

Zone #	Lites Space Sens	Lites RA Sens	Lites CLF	Peop Lat	Peop Sens	Peop CLF	Misc. Equip Lat	Misc. Equip Sens	Misc. Equip CLF
100	0	0	.000	0	0	.000	0	859	1.000
102	0	0	.000	0	0	.000	0	1569	1.000
104	0	0	.000	0	0	.000	0	1389	1.000
106	0	0	.000	0	0	.000	0	1263	1.000
108	0	0	.000	0	0	.000	0	949	1.000
110	0	0	.000	0	0	.000	0	1389	1.000
112	0	0	.000	0	0	.000	0	1106	1.000
114	0	0	.000	0	0	.000	0	1106	1.000
116	0	0	.000	0	0	.000	0	561	1.000
118	0	0	.000	0	0	.000	0	333	1.000
120	0	0	.000	0	0	.000	0	1106	1.000
Pk 1	0	0	.000	0	0	.000	0	11637	1.000
Bk 1	0	0	.000	0	0	.000	0	11637	1.000
200	0	0	.000	0	0	.000	0	1389	1.000
202	0	0	.000	0	0	.000	0	1161	1.000
204	0	0	.000	0	0	.000	0	541	1.000
206	0	0	.000	0	0	.000	0	1389	1.000
208	0	0	.000	0	0	.000	0	1389	1.000
210	0	0	.000	0	0	.000	0	541	1.000
212	0	0	.000	0	0	.000	0	1132	1.000
214	0	0	.000	0	0	.000	0	1467	1.000
216	0	0	.000	0	0	.000	0	926	1.000
218	0	0	.000	0	0	.000	0	845	1.000
220	0	0	.000	0	0	.000	0	902	1.000
Pk 2	0	0	.000	0	0	.000	0	11688	1.000
Bk 2	0	0	.000	0	0	.000	0	11688	1.000

***** CUSTOMER DIRECT SERVICE NETWORK *****
 For exclusive use by: HENRY ALFONZO

V 6.08
 PAGE 8

-----Internal Loads-----									
Zone #	Lites Space Sens	Lites RA Sens	Lites CLF	Peop Lat	Peop Sens	Peop CLF	Misc Equip Lat	Misc Equip Sens	Misc Equip CLF
288	3052	0	1.000	410	490	1.000	0	872	1.000
290	3332	0	1.000	615	735	1.000	0	952	1.000
292	5178	0	1.000	0	0	.000	0	0	.000
294	4134	0	1.000	0	0	.000	0	0	.000
296	5021	0	1.000	0	0	.000	0	0	.000
298	18606	0	1.000	0	0	.000	0	0	.000
300	15432	0	1.000	2460	2940	1.000	0	3858	1.000
302	1264	0	1.000	205	245	1.000	0	361	1.000
304	1888	0	1.000	205	245	1.000	0	539	1.000
306	6714	0	1.000	410	490	1.000	0	1918	1.000
308	2268	0	1.000	205	245	1.000	0	1296	1.000
310	7597	0	1.000	615	735	1.000	0	2170	1.000
312	1387	0	1.000	205	245	1.000	0	396	1.000
314	807	0	1.000	205	245	1.000	0	230	1.000
316	5116	0	1.000	410	490	1.000	0	1461	1.000
318	15236	0	1.000	2460	2940	1.000	0	3809	1.000
320	1571	0	1.000	205	245	1.000	0	449	1.000
322	1663	0	1.000	205	245	1.000	0	475	1.000
Pk 3	100275	0	1.000	8815	10535	1.000	0	18791	1.000
Bk 3	100275	0	1.000	8815	10535	1.000	0	18791	1.000
324	11022	0	1.000	1640	1960	1.000	0	2755	1.000
326	939	0	1.000	205	245	1.000	0	268	1.000
328	1452	0	1.000	205	245	1.000	0	415	1.000
330	2507	0	1.000	820	980	1.000	0	716	1.000
332	838	0	1.000	205	245	1.000	0	239	1.000
334	2060	0	1.000	410	490	1.000	0	588	1.000
336	1030	0	1.000	205	245	1.000	0	294	1.000
338	4463	0	1.000	820	980	1.000	0	1115	1.000
340	1026	0	1.000	205	245	1.000	0	0	.000
342	3640	0	1.000	615	735	1.000	0	0	.000
344	3173	0	1.000	410	490	1.000	0	906	1.000
346	1621	0	1.000	205	245	1.000	0	463	1.000
350	18606	0	1.000	0	0	.000	0	0	.000
352	18606	0	1.000	0	0	.000	0	0	.000
354	3542	0	1.000	0	0	.000	0	0	.000
356	5021	0	1.000	0	0	.000	0	0	.000
358	2791	0	1.000	1230	1470	1.000	0	797	1.000
Pk 4	82345	0	1.000	7175	8575	1.000	0	8561	1.000
Bk 4	82345	0	1.000	7175	8575	1.000	0	8561	1.000
360	0	0	.000	0	0	.000	0	3108	1.000
Pk 5	0	0	.000	0	0	.000	0	3108	1.000
Bk 5	0	0	.000	0	0	.000	0	3108	1.000

Zone #	-----Ventilation-----				-----Infiltration-----				--Pulldown--	
	Cfm	Sens	Latent	TD	Cfm	Sens	Latent	TD	Sens	TD
100	1005	20033	37482	20.0	0	0	0	.0	0	.0
102	1500	29900	55944	20.0	0	0	0	.0	0	.0
104	1340	26710	49976	20.0	0	0	0	.0	0	.0
106	1280	25514	47738	20.0	0	0	0	.0	0	.0

***** CUSTOMER DIRECT SERVICE NETWORK *****
 For exclusive use by: HENRY ALFONZO

V 6.08
 PAGE 9

Zone #	-----Ventilation-----				-----Infiltration-----				--Pulldown--	
	Cfm	Sens	Latent	TD	Cfm	Sens	Latent	TD	Sens	TD
108	1115	22225	41585	20.0	0	0	0	.0	0	.0
110	1340	26710	49976	20.0	0	0	0	.0	0	.0
112	1195	23820	44568	20.0	0	0	0	.0	0	.0
114	1195	23820	44568	20.0	0	0	0	.0	0	.0
116	500	9966	18648	20.0	0	0	0	.0	0	.0
118	630	12558	23496	20.0	0	0	0	.0	0	.0
120	1195	23820	44568	20.0	0	0	0	.0	0	.0
Pk 1	12295	245083	458555	20.0	0	0	0	.0	0	.0
Bk 1	12295	245083	458555	20.0	0	0	0	.0	0	.0
200	1370	27308	51095	20.0	0	0	0	.0	0	.0
202	1245	24817	46433	20.0	0	0	0	.0	0	.0
204	315	6279	11748	20.0	0	0	0	.0	0	.0
206	1370	27308	51095	20.0	0	0	0	.0	0	.0
208	1370	27308	51095	20.0	0	0	0	.0	0	.0
210	315	6279	11748	20.0	0	0	0	.0	0	.0
212	1235	24617	46060	20.0	0	0	0	.0	0	.0
214	1540	30697	57435	20.0	0	0	0	.0	0	.0
216	1100	21926	41025	20.0	0	0	0	.0	0	.0
218	1000	19933	37296	20.0	0	0	0	.0	0	.0
220	1025	20431	38228	20.0	0	0	0	.0	0	.0
Pk 2	11885	236910	443263	20.0	0	0	0	.0	0	.0
Bk 2	11885	236910	443263	20.0	0	0	0	.0	0	.0
288	30	328	1070	11.0	0	0	0	.0	0	.0
290	45	493	1605	11.0	0	0	0	.0	0	.0
292	0	0	0	.0	0	0	0	.0	0	.0
294	0	0	0	.0	0	0	0	.0	0	.0
296	0	0	0	.0	0	0	0	.0	0	.0
298	0	0	0	.0	0	0	0	.0	0	.0
300	180	717	5027	4.0	0	0	0	.0	0	.0
302	15	-59	535	-4.0	0	0	0	.0	0	.0
304	15	-59	535	-4.0	0	0	0	.0	0	.0
306	30	-119	1070	-4.0	0	0	0	.0	0	.0
308	15	-59	535	-4.0	0	0	0	.0	0	.0
310	45	-179	1605	-4.0	0	0	0	.0	0	.0
312	15	-59	535	-4.0	0	0	0	.0	0	.0
314	15	-59	535	-4.0	0	0	0	.0	0	.0
316	30	-119	1070	-4.0	0	0	0	.0	0	.0
318	180	1794	6491	10.0	0	0	0	.0	0	.0
320	15	-59	535	-4.0	0	0	0	.0	0	.0
322	15	89	540	6.0	0	0	0	.0	0	.0
Pk 3	645	2646	21692	4.1	0	0	0	.0	0	.0
Bk 3	645	6428	23261	10.0	0	0	0	.0	0	.0
324	120	717	3841	6.0	0	0	0	.0	0	.0
326	15	-59	474	-4.0	0	0	0	.0	0	.0
328	15	-59	474	-4.0	0	0	0	.0	0	.0
330	60	-239	1897	-4.0	0	0	0	.0	0	.0
332	15	-59	474	-4.0	0	0	0	.0	0	.0
334	30	-119	948	-4.0	0	0	0	.0	0	.0
336	15	-59	474	-4.0	0	0	0	.0	0	.0
338	60	-239	1897	-4.0	0	0	0	.0	0	.0
340	170	2202	5376	13.0	0	0	0	.0	0	.0
342	600	7774	18975	13.0	0	0	0	.0	0	.0

***** CUSTOMER DIRECT SERVICE NETWORK *****
 For exclusive use by: HENRY ALFONZO

V 6.08
 PAGE 10

Zone #	-----Ventilation-----				-----Infiltration-----				--Pulldown--	
	Cfm	Sens	Latent	TD	Cfm	Sens	Latent	TD	Sens	TD
344	30	-119	948	-4.0	0	0	0	.0	0	.0
346	15	-59	474	-4.0	0	0	0	.0	0	.0
350	0	0	0	.0	0	0	0	.0	0	.0
352	0	0	0	.0	0	0	0	.0	0	.0
354	0	0	0	.0	0	0	0	.0	0	.0
356	0	0	0	.0	0	0	0	.0	0	.0
358	90	538	2846	6.0	0	0	0	.0	0	.0
Pk 4	1235	10215	39105	8.3	0	0	0	.0	0	.0
Bk 4	1235	8616	39111	7.0	0	0	0	.0	0	.0
360	2980	59402	111142	20.0	0	0	0	.0	0	.0
Pk 5	2980	59402	111142	20.0	0	0	0	.0	0	.0
Bk 5	2980	59402	111142	20.0	0	0	0	.0	0	.0

Zone #	----- Duct Heat/Fan Heat/Reheat -----									
	Duct Heat Pickup	Supply Fan Heat	Return Fan Heat	Room Exhaust Airflow	Return Air Airflow	Exhaust RA Btuh	Reheat Airflow	Divers. Factor	Over/Under Sizing	
100	0	1317	0	1005	0	0	0	100	0	
102	0	1966	0	1500	0	0	0	100	0	
104	0	1756	0	1340	0	0	0	100	0	
106	0	1678	0	1280	0	0	0	100	0	
108	0	1461	0	1115	0	0	0	100	0	
110	0	1756	0	1340	0	0	0	100	0	
112	0	1566	0	1195	0	0	0	100	0	
114	0	1566	0	1195	0	0	0	100	0	
116	0	655	0	500	0	0	0	100	0	
118	0	826	0	630	0	0	0	100	0	
120	0	1566	0	1195	0	0	0	100	0	
Pk 1	0	16121	0	12295	0	0	0	100	0	
Bk 1	0	16121	0	12295	0	0	0	100	0	
200	0	1796	0	1370	0	0	0	100	0	
202	0	1632	0	1245	0	0	0	100	0	
204	0	413	0	315	0	0	0	100	0	
206	0	1796	0	1370	0	0	0	100	0	
208	0	1796	0	1370	0	0	0	100	0	
210	0	413	0	315	0	0	0	100	0	
212	0	1619	0	1235	0	0	0	100	0	
214	0	2019	0	1540	0	0	0	100	0	
216	0	1442	0	1100	0	0	0	100	0	
218	0	1311	0	1000	0	0	0	100	0	
220	0	1343	0	1025	0	0	0	100	0	
Pk 2	0	15583	0	11885	0	0	0	100	0	
Bk 2	0	15583	0	11885	0	0	0	100	0	
288	0	302	0	30	432	0	0	96	0	
290	0	283	0	45	388	0	0	97	0	
292	0	191	0	0	291	0	0	97	0	
294	0	152	0	0	232	0	0	97	0	
296	0	185	0	0	282	0	0	97	0	
298	0	686	0	0	1046	0	0	97	0	
300	0	1284	0	180	1779	0	0	74	0	
302	0	68	0	15	88	0	0	98	0	

***** CUSTOMER DIRECT SERVICE NETWORK *****
 For exclusive use by: HENRY ALFONZO

V 6.08
 PAGE 11

Zone #	Duct Heat Pickup	Supply Fan Heat	Return Fan Heat	Room Exhaust Airflow	Return Air Airflow	Exhaust RA Btuh	Reheat Airflow	Divers. Factor	Over/Under Sizing
304	0	97	0	15	133	0	0	98	0
306	0	333	0	30	478	0	0	98	0
308	0	138	0	15	196	0	0	98	0
310	0	383	0	45	539	0	0	98	0
312	0	73	0	15	97	0	0	98	0
314	0	46	0	15	56	0	0	98	0
316	0	258	0	30	363	0	0	98	0
318	0	1128	0	180	1541	0	0	100	0
320	0	82	0	15	111	0	0	98	0
322	0	116	0	15	163	0	0	97	0
Pk 3	0	5814	0	645	8224	0	0	100	0
Bk 3	0	5814	0	645	8224	0	0	93	0
324	0	770	0	120	1054	0	0	99	0
326	0	57	0	15	73	0	0	99	0
328	0	84	0	15	113	0	0	99	0
330	0	167	0	60	194	0	0	99	0
332	0	52	0	15	65	0	0	99	0
334	0	125	0	30	160	0	0	99	0
336	0	62	0	15	80	0	0	99	0
338	0	260	0	60	337	0	0	99	0
340	0	111	0	170	0	0	0	99	0
342	0	393	0	600	0	0	0	99	0
344	0	182	0	30	247	0	0	99	0
346	0	92	0	15	126	0	0	99	0
350	0	750	0	0	1144	0	0	98	0
352	0	750	0	0	1144	0	0	98	0
354	0	142	0	0	217	0	0	98	0
356	0	202	0	0	308	0	0	98	0
358	0	266	0	90	316	0	0	91	0
Pk 4	0	4472	0	1235	5587	0	0	100	0
Bk 4	0	4472	0	1235	5587	0	0	98	0
360	0	3907	0	2980	0	0	0	100	0
Pk 5	0	3907	0	2980	0	0	0	100	0
Bk 5	0	3907	0	2980	0	0	0	100	0

***** CUSTOMER DIRECT SERVICE NETWORK *****
 For exclusive use by: HENRY ALFONZO

V 6.08
 PAGE 12

SYSTEM	1	VTCV	CLG	SPACE	LOAD	PEAK	CHECKSUMS		
	Space	Space	Space	Tot RA	Exh RA	Net	% of		
	Sens	Latent	Sen+Lat	Sens	Sens	Total	Total		
Envelope	0		0			0	.00		
Sksolr	0		0			0	.00		
Skcond	0		0	0	0	0	.00		
Rfcond	0		0			0	.00		
Glsolr	0		0			0	.00		
Glcond	0		0			0	.00		
Wlcond	0		0	0	0	0	.00		
Xfcond	0		0			0	.00		
Infil	0	0	0			0	.00		
Total	0	0	0	0	0	0	.00		
Internal									
Lights	0		0	0	0	0	.00		
People	0	0	0			0	.00		
Misc	11637	0	11637			11637	1.59		
Part	0		0			0	.00		
Total	11637	0	11637	0	0	11637	1.59		
Pulldown	0		0			0	.00		
OA Load	0	0	0			703638	96.20		
SFan Heat						16121	2.20		
RFan Heat				0	0	0	.00		
Duct Heat				0	0	0	.00		
Sizing	0		0			0	.00		
TOTALS	11637	0	11637	0	0	731396	100.00		

SYSTEM	2	VTCV	CLG	SPACE	LOAD	PEAK	CHECKSUMS		
	Space	Space	Space	Tot RA	Exh RA	Net	% of		
	Sens	Latent	Sen+Lat	Sens	Sens	Total	Total		
Envelope	0		0			0	.00		
Sksolr	0		0			0	.00		
Skcond	0		0	0	0	0	.00		
Rfcond	0		0			0	.00		
Glsolr	0		0			0	.00		
Glcond	0		0			0	.00		
Wlcond	0		0	0	0	0	.00		
Xfcond	0		0			0	.00		
Infil	0	0	0			0	.00		
Total	0	0	0	0	0	0	.00		
Internal									
Lights	0		0	0	0	0	.00		
People	0	0	0			0	.00		
Misc	11688	0	11688			11688	1.65		
Part	0		0			0	.00		
Total	11688	0	11688	0	0	11688	1.65		
Pulldown	0		0			0	.00		
OA Load	0	0	0			680174	96.15		
SFan Heat						15583	2.20		
RFan Heat				0	0	0	.00		
Duct Heat				0	0	0	.00		
Sizing	0		0			0	.00		
TOTALS	11688	0	11688	0	0	707445	100.00		

***** CUSTOMER DIRECT SERVICE NETWORK *****
 For exclusive use by: HENRY ALFONZO

V 6.08
 PAGE 13

SYSTEM	3	VTCV	CLG	SPACE	LOAD	PEAK	CHECKSUMS		
	Space	Space	Space	Space	Tot RA	Exh RA	Net	% of	
Envelope	Sens	Latent	Sen+Lat		Sens	Sens	Total	Total	
Sksolr	0		0				0	.00	
Skcond	0		0		0	0	0	.00	
Rfcond	0		0		0	0	0	.00	
Glsolr	24060		24060				24060	11.88	
Glcond	1590		1590				1590	.79	
Wlcond	6422		6422		0	0	6422	3.17	
Xfcond	1863		1863				1863	.92	
Infil	0	0	0				0	.00	
Total	33935	0	33935		0	0	33935	16.76	
Internal									
Lights	100275		100275		0	0	100275	49.52	
People	10535	8815	19350				19350	9.56	
Misc	18791	0	18791				18791	9.28	
Part	0		0				0	.00	
Total	129601	8815	138416		0	0	138416	68.35	
Pulldown	0		0				0	.00	
OA Load	0	0	0				24338	12.02	
SFan Heat							5814	2.87	
RFan Heat					0	0	0	.00	
Duct Heat					0	0	0	.00	
Sizing	0		0				0	.00	
TOTALS	163536	8815	172351		0	0	202503	100.00	

SYSTEM	4	VTCV	CLG	SPACE	LOAD	PEAK	CHECKSUMS		
	Space	Space	Space	Space	Tot RA	Exh RA	Net	% of	
Envelope	Sens	Latent	Sen+Lat		Sens	Sens	Total	Total	
Sksolr	0		0				0	.00	
Skcond	0		0		0	0	0	.00	
Rfcond	0		0		0	0	0	.00	
Glsolr	1436		1436				1436	.85	
Glcond	59		59				59	.03	
Wlcond	4120		4120		0	0	4120	2.44	
Xfcond	2615		2615				2615	1.55	
Infil	0	0	0				0	.00	
Total	8230	0	8230		0	0	8230	4.88	
Internal									
Lights	82345		82345		0	0	82345	48.82	
People	8575	7175	15750				15750	9.34	
Misc	8561	0	8561				8561	5.08	
Part	0		0				0	.00	
Total	99481	7175	106656		0	0	106656	63.23	
Pulldown	0		0				0	.00	
OA Load	0	0	0				49321	29.24	
SFan Heat							4472	2.65	
RFan Heat					0	0	0	.00	
Duct Heat					0	0	0	.00	
Sizing	0		0				0	.00	
TOTALS	107711	7175	114886		0	0	168679	100.00	

***** CUSTOMER DIRECT SERVICE NETWORK *****
 For exclusive use by: HENRY ALFONZO

V 6.08
 PAGE 14

SYSTEM	5	VTCV	CLG	SPACE	LOAD	PEAK	CHECKSUMS		
	Space	Space	Space	Tot RA	Exh RA	Net	% of		
Envelope	Sens	Latent	Sen+Lat	Sens	Sens	Total	Total		
Sksolr	0		0			0	.00		
Skcond	0		0	0	0	0	.00		
Rfcond	0		0	0	0	0	.00		
Glsolr	0		0			0	.00		
Glcond	0		0			0	.00		
Wlcond	0		0	0	0	0	.00		
Xfcond	0		0			0	.00		
Infil	0	0	0			0	.00		
Total	0	0	0	0	0	0	.00		
Internal									
Lights	0		0	0	0	0	.00		
People	0	0	0			0	.00		
Misc	3108	0	3108			3108	1.75		
Part	0		0			0	.00		
Total	3108	0	3108	0	0	3108	1.75		
Pulldown	0		0			0	.00		
OA Load	0	0	0			170544	96.05		
SFan Heat						3907	2.20		
RFan Heat				0	0	0	.00		
Duct Heat				0	0	0	.00		
Sizing	0		0			0	.00		
TOTALS	3108	0	3108	0	0	177559	100.00		

SYSTEM	1	VTCV	CLG	COIL	LOAD	PEAK	CHECKSUMS		
	Space	Space	Space	Tot RA	Exh RA	Net	% of		
Envelope	Sens	Latent	Sen+Lat	Sens	Sens	Total	Total		
Sksolr	0		0			0	.00		
Skcond	0		0	0	0	0	.00		
Rfcond	0		0	0	0	0	.00		
Glsolr	0		0			0	.00		
Glcond	0		0			0	.00		
Wlcond	0		0	0	0	0	.00		
Xfcond	0		0			0	.00		
Infil	0	0	0			0	.00		
Total	0	0	0	0	0	0	.00		
Internal									
Lights	0		0	0	0	0	.00		
People	0	0	0			0	.00		
Misc	11637	0	11637			11637	1.59		
Part	0		0			0	.00		
Total	11637	0	11637	0	0	11637	1.59		
Pulldown	0		0			0	.00		
OA Load	0	0	0			703638	96.20		
SFan Heat						16121	2.20		
RFan Heat				0	0	0	.00		
Duct Heat				0	0	0	.00		
Sizing	0		0			0	.00		
TOTALS	11637	0	11637	0	0	731396	100.00		

***** CUSTOMER DIRECT SERVICE NETWORK *****
 For exclusive use by: HENRY ALFONZO

V 6.08
 PAGE 15

SYSTEM	2	VTCV	CLG COIL	LOAD	PEAK	CHECKSUMS	
	Space	Space	Space	Tot RA	Exh RA	Net	% of
Envelope	Sens	Latent	Sen+Lat	Sens	Sens	Total	Total
Sksolr	0		0			0	.00
Skcond	0		0	0	0	0	.00
Rfcond	0		0	0	0	0	.00
Glsolr	0		0			0	.00
Glcond	0		0			0	.00
Wlcond	0		0	0	0	0	.00
Xfcond	0		0			0	.00
Infil	0	0	0			0	.00
Total	0	0	0	0	0	0	.00
Internal							
Lights	0		0	0	0	0	.00
People	0	0	0			0	.00
Misc	11688	0	11688			11688	1.65
Part	0		0			0	.00
Total	11688	0	11688	0	0	11688	1.65
Pulldown	0		0			0	.00
OA Load	0	0	0			680174	96.15
SFan Heat						15583	2.20
RFan Heat				0	0	0	.00
Duct Heat				0	0	0	.00
Sizing	0		0			0	.00
TOTALS	11688	0	11688	0	0	707445	100.00

SYSTEM	3	VTCV	CLG COIL	LOAD	PEAK	CHECKSUMS	
	Space	Space	Space	Tot RA	Exh RA	Net	% of
Envelope	Sens	Latent	Sen+Lat	Sens	Sens	Total	Total
Sksolr	0		0			0	.00
Skcond	0		0	0	0	0	.00
Rfcond	0		0	0	0	0	.00
Glsolr	24067		24067			24067	11.72
Glcond	1591		1591			1591	.77
Wlcond	6396		6396	0	0	6396	3.12
Xfcond	1370		1370			1370	.67
Infil	0	0	0			0	.00
Total	33424	0	33424	0	0	33424	16.28
Internal							
Lights	100275		100275	0	0	100275	48.84
People	10535	8815	19350			19350	9.42
Misc	18791	0	18791			18791	9.15
Part	0		0			0	.00
Total	129601	8815	138416	0	0	138416	67.41
Pulldown	0		0			0	.00
OA Load	0	0	0			27672	13.48
SFan Heat						5814	2.83
RFan Heat				0	0	0	.00
Duct Heat				0	0	0	.00
Sizing	0		0			0	.00
TOTALS	163025	8815	171840	0	0	205326	100.00

***** CUSTOMER DIRECT SERVICE NETWORK *****
 For exclusive use by: HENRY ALFONZO

V 6.08
 PAGE 16

SYSTEM	4	VTCV	CLG COIL	LOAD	PEAK	CHECKSUMS		
	Space	Space	Space	Tot RA	Exh RA	Net	% of	
Envelope	Sens	Latent	Sen+Lat	Sens	Sens	Total	Total	
Sksolr	0		0			0	.00	
Skcond	0		0	0	0	0	.00	
Rfcond	0		0	0	0	0	.00	
Glsolr	907		907			907	.52	
Glcond	237		237			237	.14	
Wlcond	4101		4101	0	0	4101	2.36	
Xfcond	2318		2318			2318	1.34	
Infil	0	0	0			0	.00	
Total	7563	0	7563	0	0	7563	4.36	
Internal								
Lights	82345		82345	0	0	82345	47.46	
People	8575	7175	15750			15750	9.08	
Misc	8561	0	8561			8561	4.93	
Part	0		0			0	.00	
Total	99481	7175	106656	0	0	106656	61.47	
Pulldown	0		0			0	.00	
OA Load	0	0	0			54826	31.60	
SFan Heat						4472	2.58	
RFan Heat				0	0	0	.00	
Duct Heat				0	0	0	.00	
Sizing	0		0			0	.00	
TOTALS	107044	7175	114219	0	0	173517	100.00	

SYSTEM	5	VTCV	CLG COIL	LOAD	PEAK	CHECKSUMS		
	Space	Space	Space	Tot RA	Exh RA	Net	% of	
Envelope	Sens	Latent	Sen+Lat	Sens	Sens	Total	Total	
Sksolr	0		0			0	.00	
Skcond	0		0	0	0	0	.00	
Rfcond	0		0	0	0	0	.00	
Glsolr	0		0			0	.00	
Glcond	0		0			0	.00	
Wlcond	0		0	0	0	0	.00	
Xfcond	0		0			0	.00	
Infil	0	0	0			0	.00	
Total	0	0	0	0	0	0	.00	
Internal								
Lights	0		0	0	0	0	.00	
People	0	0	0			0	.00	
Misc	3108	0	3108			3108	1.75	
Part	0		0			0	.00	
Total	3108	0	3108	0	0	3108	1.75	
Pulldown	0		0			0	.00	
OA Load	0	0	0			170544	96.05	
SFan Heat						3907	2.20	
RFan Heat				0	0	0	.00	
Duct Heat				0	0	0	.00	
Sizing	0		0			0	.00	
TOTALS	3108	0	3108	0	0	177559	100.00	

***** CUSTOMER DIRECT SERVICE NETWORK *****
 For exclusive use by: HENRY ALFONZO

V 6.08
 PAGE 17

S Y S T E M 1		V T C V	P S Y C H		P O I N T S		
(Rmdbh = 62.0 F)	Dry	Wet	Rel	Humid			Temp
(Sadbh = 62.0 F)	Bulb	Bulb	Humid	Ratio	Enthal		Diff
	(F)	(F)	(%)	(GR)	(B/LB)		(F)
Room	68.0	57.7	55.3	63.3	26.32		
Return Air	68.0	57.7	55.3	63.3	26.32		.0
Return Fan0
Outdoor Air	88.0	74.6	55.1	123.6	40.81		
Return/OA Mix	88.0	74.6	55.1	123.6	40.81		
Supply Fan (Draw)							1.3
Entering Coil	88.0	74.6	55.1	123.6	40.81		
Leaving Coil	51.7	51.6	99.6	63.6	22.40		
Supply Duct Heat Gain .							.0
Supply Air	53.0	52.1	94.9	63.6	22.72		
Opt Vent System	88.0	74.6	55.1	123.6	40.81		
Percent OA	100.0						.0
Coil/Space SHR's37/1.00						.0
Coil Cfm	778.						60.9
			Bypass Factor (%)0
			Over/Under Sizing Mbh0
			Coil Tonnage				60.9

S Y S T E M 2		V T C V	P S Y C H		P O I N T S		
(Rmdbh = 62.0 F)	Dry	Wet	Rel	Humid			Temp
(Sadbh = 62.0 F)	Bulb	Bulb	Humid	Ratio	Enthal		Diff
	(F)	(F)	(%)	(GR)	(B/LB)		(F)
Room	68.0	57.7	55.3	63.3	26.32		
Return Air	68.0	57.7	55.3	63.3	26.32		.0
Return Fan0
Outdoor Air	88.0	74.6	55.1	123.6	40.81		
Return/OA Mix	88.0	74.6	55.1	123.6	40.81		
Supply Fan (Draw)							1.3
Entering Coil	88.0	74.6	55.1	123.6	40.81		
Leaving Coil	51.7	51.6	99.6	63.6	22.40		
Supply Duct Heat Gain .							.0
Supply Air	53.0	52.1	94.9	63.6	22.72		
Opt Vent System	88.0	74.6	55.1	123.6	40.81		
Percent OA	100.0						.0
Coil/Space SHR's37/1.00						.0
Coil Cfm	782.						59.0
			Bypass Factor (%)0
			Over/Under Sizing Mbh0
			Coil Tonnage				59.0

S Y S T E M 3		V T C V	P S Y C H		P O I N T S		
(Rmdbh = 62.0 F)	Dry	Wet	Rel	Humid			Temp
(Sadbh = 62.0 F)	Bulb	Bulb	Humid	Ratio	Enthal		Diff
	(F)	(F)	(%)	(GR)	(B/LB)		(F)
Room	75.0	60.7	45.4	65.9	28.44		
Return Air	75.0	60.7	45.4	65.9	28.44		.0
Return Fan0
Outdoor Air	86.0	74.1	58.8	123.7	40.33		
Return/OA Mix	75.8	61.8	47.0	70.1	29.30		
Supply Fan (Draw)7
Entering Coil	75.8	61.8	47.0	70.1	29.30		
Leaving Coil	55.8	53.5	87.1	64.8	23.59		
Supply Duct Heat Gain .							.0
Supply Air	56.5	53.8	85.0	64.8	23.75		
Opt Vent System	86.0	74.1	58.8	123.7	40.33		
Percent OA	7.3						.0
Coil/Space SHR's85/ .95						.0
Coil Cfm	8869.						17.1
			Bypass Factor (%)0
			Over/Under Sizing Mbh0
			Coil Tonnage				17.1

***** CUSTOMER DIRECT SERVICE NETWORK *****
 For exclusive use by: HENRY ALFONZO

V 6.08
 PAGE 18

S Y S T E M 4		V T C V		P S Y C H		P O I N T S	
(Rmdbh = 62.0 F)	Dry	Wet	Rel	Humid			Temp
(Sadbh = 62.0 F)	Bulb	Bulb	Humid	Ratio	Enthal		Diff
	(F)	(F)	(%)	(GR)	(B/LB)		(F)
Room	75.0	62.0	49.9	72.4	29.48		
Return Air	75.0	62.0	49.9	72.4	29.48		.0
Return Fan0
Outdoor Air	88.0	74.6	55.2	123.7	40.82		
Return/OA Mix	77.5	64.8	52.0	82.3	31.67		
Supply Fan (Draw)7
Entering Coil	77.5	64.8	52.0	82.3	31.67		
Leaving Coil	57.4	55.6	90.2	71.2	24.98		
Supply Duct Heat Gain .							.0
Supply Air	58.1	55.9	88.1	71.2	25.14		
Opt Vent System	88.0	74.6	55.2	123.7	40.82		
Percent OA	19.3			Bypass Factor (%)0
Coil/Space SHR's73/ .94			Over/Under Sizing Mbh0
Coil Cfm	6387.			Coil Tonnage			14.5

S Y S T E M 5		V T C V		P S Y C H		P O I N T S	
(Rmdbh = 62.0 F)	Dry	Wet	Rel	Humid			Temp
(Sadbh = 62.0 F)	Bulb	Bulb	Humid	Ratio	Enthal		Diff
	(F)	(F)	(%)	(GR)	(B/LB)		(F)
Room	68.0	57.7	55.3	63.3	26.32		
Return Air	68.0	57.7	55.3	63.3	26.32		.0
Return Fan0
Outdoor Air	88.0	74.6	55.1	123.6	40.81		
Return/OA Mix	88.0	74.6	55.1	123.6	40.81		
Supply Fan (Draw)							1.3
Entering Coil	88.0	74.6	55.1	123.6	40.81		
Leaving Coil	51.7	51.6	99.6	63.6	22.40		
Supply Duct Heat Gain .							.0
Supply Air	53.0	52.1	94.9	63.6	22.72		
Opt Vent System	88.0	74.6	55.1	123.6	40.81		
Percent OA	100.0			Bypass Factor (%)0
Coil/Space SHR's37/1.00			Over/Under Sizing Mbh0
Coil Cfm	208.			Coil Tonnage			14.8

***** CUSTOMER DIRECT SERVICE NETWORK *****
 For exclusive use by: HENRY ALFONZO

V 6.08
 PAGE 19

Z O N E P S Y C H P O I N T S

Zone #	Room SHR	Coil SHR	-----Room-----			----Coil Entr----			-----Coil Lvg-----			Clg SADB (F)
			Dry Bulb (F)	Wet Bulb (F)	Humid Ratio (GR)	Dry Bulb (F)	Wet Bulb (F)	Humid Ratio (GR)	Dry Bulb (F)	Wet Bulb (F)	Humid Ratio (GR)	
100	1.00	.37	68.0	57.7	63.3	88.0	74.6	123.6	51.7	51.6	63.6	67.1
102	1.00	.37	68.0	57.7	63.3	88.0	74.6	123.6	51.7	51.6	63.6	66.9
104	1.00	.37	68.0	57.7	63.3	88.0	74.6	123.6	51.7	51.6	63.6	67.0
106	1.00	.37	68.0	57.7	63.3	88.0	74.6	123.6	51.7	51.6	63.6	67.0
108	1.00	.37	68.0	57.7	63.3	88.0	74.6	123.6	51.7	51.6	63.6	67.1
110	1.00	.37	68.0	57.7	63.3	88.0	74.6	123.6	51.7	51.6	63.6	67.0
112	1.00	.37	68.0	57.7	63.3	88.0	74.6	123.6	51.7	51.6	63.6	67.1
114	1.00	.37	68.0	57.7	63.3	88.0	74.6	123.6	51.7	51.6	63.6	67.1
116	1.00	.37	68.0	57.7	63.3	88.0	74.6	123.6	51.7	51.6	63.6	66.9
118	1.00	.37	68.0	57.7	63.3	88.0	74.6	123.6	51.7	51.6	63.6	67.5
120	1.00	.37	68.0	57.7	63.3	88.0	74.6	123.6	51.7	51.6	63.6	67.1
200	1.00	.37	68.0	57.7	63.3	88.0	74.6	123.6	51.7	51.6	63.6	67.0
202	1.00	.37	68.0	57.7	63.3	88.0	74.6	123.6	51.7	51.6	63.6	67.1
204	1.00	.38	68.0	57.7	63.3	88.0	74.6	123.6	51.7	51.6	63.6	66.3
206	1.00	.37	68.0	57.7	63.3	88.0	74.6	123.6	51.7	51.6	63.6	67.0
208	1.00	.37	68.0	57.7	63.3	88.0	74.6	123.6	51.7	51.6	63.6	67.0
210	1.00	.38	68.0	57.7	63.3	88.0	74.6	123.6	51.7	51.6	63.6	66.3
212	1.00	.37	68.0	57.7	63.3	88.0	74.6	123.6	51.7	51.6	63.6	67.1
214	1.00	.37	68.0	57.7	63.3	88.0	74.6	123.6	51.7	51.6	63.6	67.0
216	1.00	.37	68.0	57.7	63.3	88.0	74.6	123.6	51.7	51.6	63.6	67.2
218	1.00	.37	68.0	57.7	63.3	88.0	74.6	123.6	51.7	51.6	63.6	67.2
220	1.00	.37	68.0	57.7	63.3	88.0	74.6	123.6	51.7	51.6	63.6	67.1
288	.95	.86	75.0	60.7	65.9	75.8	61.8	70.1	55.8	53.5	64.8	56.5
290	.93	.80	75.0	60.7	65.9	75.8	61.8	70.1	55.8	53.5	64.8	56.5
292	1.00	1.00	75.0	60.7	65.9	75.8	61.8	70.1	55.8	53.5	64.8	56.5
294	1.00	1.00	75.0	60.7	65.9	75.8	61.8	70.1	55.8	53.5	64.8	56.5
296	1.00	1.00	75.0	60.7	65.9	75.8	61.8	70.1	55.8	53.5	64.8	56.5
298	1.00	1.00	75.0	60.7	65.9	75.8	61.8	70.1	55.8	53.5	64.8	56.5
300	.94	.84	75.0	60.7	65.9	75.8	61.8	70.1	55.8	53.5	64.8	56.5
302	.90	.74	75.0	60.7	65.9	75.8	61.8	70.1	55.8	53.5	64.8	56.5
304	.93	.80	75.0	60.7	65.9	75.8	61.8	70.1	55.8	53.5	64.8	56.5
306	.96	.87	75.0	60.7	65.9	75.8	61.8	70.1	55.8	53.5	64.8	56.5
308	.95	.85	75.0	60.7	65.9	75.8	61.8	70.1	55.8	53.5	64.8	56.5
310	.95	.84	75.0	60.7	65.9	75.8	61.8	70.1	55.8	53.5	64.8	56.5
312	.91	.76	75.0	60.7	65.9	75.8	61.8	70.1	55.8	53.5	64.8	56.5
314	.86	.68	75.0	60.7	65.9	75.8	61.8	70.1	55.8	53.5	64.8	56.5
316	.95	.84	75.0	60.7	65.9	75.8	61.8	70.1	55.8	53.5	64.8	56.5
318	.93	.79	75.0	60.7	65.9	75.8	61.8	70.1	55.8	53.5	64.8	56.5
320	.92	.78	75.0	60.7	65.9	75.8	61.8	70.1	55.8	53.5	64.8	56.5
322	.94	.82	75.0	60.7	65.9	75.8	61.8	70.1	55.8	53.5	64.8	56.5
324	.92	.80	75.0	62.0	72.4	77.5	64.8	82.3	57.4	55.6	71.2	58.1
326	.88	.72	75.0	62.0	72.4	77.5	64.8	82.3	57.4	55.6	71.2	58.1
328	.91	.78	75.0	62.0	72.4	77.5	64.8	82.3	57.4	55.6	71.2	58.1
330	.84	.66	75.0	62.0	72.4	77.5	64.8	82.3	57.4	55.6	71.2	58.1
332	.87	.70	75.0	62.0	72.4	77.5	64.8	82.3	57.4	55.6	71.2	58.1
334	.89	.73	75.0	62.0	72.4	77.5	64.8	82.3	57.4	55.6	71.2	58.1
336	.89	.73	75.0	62.0	72.4	77.5	64.8	82.3	57.4	55.6	71.2	58.1
338	.89	.74	75.0	62.0	72.4	77.5	64.8	82.3	57.4	55.6	71.2	58.1
340	.86	.39	75.0	62.0	72.4	77.5	64.8	82.3	57.4	55.6	71.2	67.5
342	.88	.39	75.0	62.0	72.4	77.5	64.8	82.3	57.4	55.6	71.2	67.7
344	.92	.79	75.0	62.0	72.4	77.5	64.8	82.3	57.4	55.6	71.2	58.1
346	.92	.80	75.0	62.0	72.4	77.5	64.8	82.3	57.4	55.6	71.2	58.1
350	1.00	1.00	75.0	62.0	72.4	77.5	64.8	82.3	57.4	55.6	71.2	58.1

***** CUSTOMER DIRECT SERVICE NETWORK *****
 For exclusive use by: HENRY ALFONZO

V 6.08
 PAGE 20

Z O N E P S Y C H P O I N T S												
Zone #	Room SHR	Coil SHR	-----Room-----			----Coil Entr----			-----Coil Lvg-----			Clg SADB (F)
			Dry Bulb (F)	Wet Bulb (F)	Humid Ratio (GR)	Dry Bulb (F)	Wet Bulb (F)	Humid Ratio (GR)	Dry Bulb (F)	Wet Bulb (F)	Humid Ratio (GR)	
352	1.00	1.00	75.0	62.0	72.4	77.5	64.8	82.3	57.4	55.6	71.2	58.1
354	1.00	1.00	75.0	62.0	72.4	77.5	64.8	82.3	57.4	55.6	71.2	58.1
356	1.00	1.00	75.0	62.0	72.4	77.5	64.8	82.3	57.4	55.6	71.2	58.1
358	.85	.67	75.0	62.0	72.4	77.5	64.8	82.3	57.4	55.6	71.2	58.1
360	1.00	.37	68.0	57.7	63.3	88.0	74.6	123.6	51.7	51.6	63.6	67.0

Notes: CFM and Coil Capacity Calculations Used the Following Information:
 Barometric Pressure = 26.8 in. Hg Partial Pressure = -.709 in. Hg
 Specific Heat = .2444 Btu/(lbm-F) Altitude-Corrected Density-Spec Heat
 Air Density = .0679 lbm/cuft Product = .9967 Btu-min/(hr-cf-F)

***** CUSTOMER DIRECT SERVICE NETWORK *****
 For exclusive use by: HENRY ALFONZO

V 6.08
 PAGE 21

-----BUILDING U-VALUES/AREAS-----										
Zone #	Description	Part	Xflr	Skyl	Roof	Glas	Wall	%Wall to-RA	Zone Mass	Zone Capac
100	QUIROFANO A-A	.000	.000	.000	.000	.000	.000	.0	80.4	16.7
102	QUIROFANO A	.000	.000	.000	.000	.000	.000	.0	80.4	16.7
104	QUIROFANO B	.000	.000	.000	.000	.000	.000	.0	80.4	16.7
106	QUIROFANO C	.000	.000	.000	.000	.000	.000	.0	80.4	16.7
108	QUIROFANO D	.000	.000	.000	.000	.000	.000	.0	80.4	16.7
110	WUIROFANO E	.000	.000	.000	.000	.000	.000	.0	80.4	16.7
112	QUIROFANO F	.000	.000	.000	.000	.000	.000	.0	80.4	16.7
114	QUIROFANO G	.000	.000	.000	.000	.000	.000	.0	80.4	16.7
116	QUIROFANO H	.000	.000	.000	.000	.000	.000	.0	80.4	16.7
118	DEPOSITO	.000	.000	.000	.000	.000	.000	.0	80.4	16.7
120	QUIROFANO I	.000	.000	.000	.000	.000	.000	.0	80.4	16.7
Sys 1	VTCV	.000	.000	.000	.000	.000	.000	.0	80.4	16.7
200	QUIROFANO N-	.000	.000	.000	.000	.000	.000	.0	80.4	16.7
202	QUIROFANO H CARD	.000	.000	.000	.000	.000	.000	.0	80.4	16.7
204	DEP. QUIF. H	.000	.000	.000	.000	.000	.000	.0	80.4	16.7
206	QUIROPFANO M	.000	.000	.000	.000	.000	.000	.0	80.4	16.7
208	QUIROFANO LL	.000	.000	.000	.000	.000	.000	.0	80.4	16.7
210	DEP QUROFANOS	.000	.000	.000	.000	.000	.000	.0	80.4	16.7
212	QUIROFANO L	.000	.000	.000	.000	.000	.000	.0	80.4	16.7
214	QUIROFANO K	.000	.000	.000	.000	.000	.000	.0	80.4	16.7
216	QUIROFANO J	.000	.000	.000	.000	.000	.000	.0	80.4	16.7
218	QUIROFANO O	.000	.000	.000	.000	.000	.000	.0	80.4	16.7
220	QUIROFANO P	.000	.000	.000	.000	.000	.000	.0	80.4	16.7
Sys 2	VTCV	.000	.000	.000	.000	.000	.000	.0	80.4	16.7
288	MATERIA ANESTECI	.000	.125	.000	.000	1.100	.217	.0	94.9	19.8
290	CENTRAL ANESTECI	.000	.125	.000	.000	1.100	.217	.0	91.5	19.1
292	.5 PASILLO SUR	.000	.125	.000	.000	.000	.000	.0	80.4	16.7
294	PASILLO N-S	.000	.125	.000	.000	.000	.000	.0	80.4	16.7
296	PASILLO NORTE	.000	.125	.000	.000	.000	.000	.0	80.4	16.7
298	PASILLO	.000	.125	.000	.000	.000	.000	.0	80.4	16.7
300	PRE ANESTECIA	.000	.125	.000	.000	1.100	.217	.0	89.9	18.7
302	DEPOSITO	.000	.125	.000	.000	.000	.000	.0	80.4	16.7
304	DEPOSITO	.000	.125	.000	.000	.000	.000	.0	80.4	16.7
306	DEP. ESTERILIZAC	.000	.125	.000	.000	.000	.000	.0	80.4	16.7
308	AUTO CLAVE	.000	.125	.000	.000	.000	.000	.0	80.4	16.7
310	FAENA LIMPIA	.000	.125	.000	.000	.000	.000	.0	80.4	16.7
312	RAYOS X	.000	.125	.000	.000	.000	.000	.0	80.4	16.7
314	DEPOSITO	.000	.125	.000	.000	.000	.000	.0	80.4	16.7
316	FAENA SUCIA	.000	.125	.000	.000	.000	.000	.0	80.4	16.7
318	RECUPERACION 1	.000	.125	.000	.000	1.100	.217	.0	90.0	18.8
320	DEPOSITO	.000	.125	.000	.000	.000	.000	.0	80.4	16.7
322	DEPOSITO	.000	.125	.000	.000	1.100	.217	.0	109.9	23.0
Sys 3	VTCV	.000	.125	.000	.000	1.100	.217	.0	84.4	17.6
324	RECUPERACION 2	.000	.125	.000	.000	1.100	.217	.0	105.5	22.1
326	CUSRTO LIMPIEZA	.000	.125	.000	.000	.000	.000	.0	80.4	16.7
328	CENTRAL SUMINIST	.000	.125	.000	.000	.000	.000	.0	80.4	16.7
330	ESTAR	.000	.125	.000	.000	.000	.000	.0	80.4	16.7
332	DEPOSITO	.000	.125	.000	.000	.000	.000	.0	80.4	16.7
334	SUPERVISOR	.000	.125	.000	.000	.000	.000	.0	80.4	16.7

***** CUSTOMER DIRECT SERVICE NETWORK *****
 For exclusive use by: HENRY ALFONZO

V 6.08
 PAGE 22

Zone #	Description	Part	Xflr	Skyl	Roof	Glas	Wall	%Wall to-RA	Zone Mass	Zone Capac
336	ANTESALA	.000	.125	.000	.000	.000	.000	.0	80.4	16.7
338	NEUROCIRUGIA	.000	.125	.000	.000	.000	.000	.0	80.4	16.7
340	CUSRTO REVELADO	.000	.000	.000	.000	.000	.000	.0	80.4	16.7
342	DEP. ANESTECIA	.000	.000	.000	.000	.000	.000	.0	80.4	16.7
344	SEPTICO	.000	.125	.000	.000	.000	.000	.0	80.4	16.7
346	DEPOSITO	.000	.125	.000	.000	.000	.000	.0	80.4	16.7
350	PASILLO A	.000	.125	.000	.000	.000	.000	.0	80.4	16.7
352	PASILLO CENTRAL	.000	.125	.000	.000	.000	.000	.0	80.4	16.7
354	PASILLO SUR	.000	.125	.000	.000	.000	.000	.0	80.4	16.7
356	PASILLO NORTE	.000	.125	.000	.000	.000	.000	.0	80.4	16.7
358	ESTAR ENFERMERAS	.000	.125	.000	.000	1.100	.217	.0	90.7	18.9
Sys 4	VTCV	.000	.125	.000	.000	1.100	.217	.0	83.8	17.4
360	SALA DE PARTO	.000	.000	.000	.000	.000	.000	.0	80.4	16.7
Sys 5	VTCV	.000	.000	.000	.000	.000	.000	.0	80.4	16.7
Tot/Av		.000	.125	.000	.000	1.100	.217	.0	82.9	17.2

Zone #	#Duplic	Flr	Zn	Flr/Zn	TotFlr	Part	Xflr	Skyl	%Sk	Roof	Glass	%Gl	Wall
100	1	1	1	251	251	0	0	0	0	0	0	0	0
102	1	1	1	460	460	0	0	0	0	0	0	0	0
104	1	1	1	407	407	0	0	0	0	0	0	0	0
106	1	1	1	370	370	0	0	0	0	0	0	0	0
108	1	1	1	278	278	0	0	0	0	0	0	0	0
110	1	1	1	407	407	0	0	0	0	0	0	0	0
112	1	1	1	324	324	0	0	0	0	0	0	0	0
114	1	1	1	324	324	0	0	0	0	0	0	0	0
116	1	1	1	164	164	0	0	0	0	0	0	0	0
118	1	1	1	97	97	0	0	0	0	0	0	0	0
120	1	1	1	324	324	0	0	0	0	0	0	0	0
Sys 1					3409	0	0	0	0	0	0	0	0
200	1	1	1	407	407	0	0	0	0	0	0	0	0
202	1	1	1	340	340	0	0	0	0	0	0	0	0
204	1	1	1	158	158	0	0	0	0	0	0	0	0
206	1	1	1	407	407	0	0	0	0	0	0	0	0
208	1	1	1	407	407	0	0	0	0	0	0	0	0
210	1	1	1	158	158	0	0	0	0	0	0	0	0
212	1	1	1	331	331	0	0	0	0	0	0	0	0
214	1	1	1	430	430	0	0	0	0	0	0	0	0
216	1	1	1	271	271	0	0	0	0	0	0	0	0
218	1	1	1	247	247	0	0	0	0	0	0	0	0
220	1	1	1	264	264	0	0	0	0	0	0	0	0
Sys 2					3424	0	0	0	0	0	0	0	0
288	1	1	1	255	255	0	255	0	0	0	47	30	105
290	1	1	1	278	278	0	248	0	0	0	32	26	88
292	1	1	1	433	433	0	433	0	0	0	0	0	0
294	1	1	1	346	346	0	346	0	0	0	0	0	0
296	1	1	1	420	420	0	420	0	0	0	0	0	0

***** CUSTOMER DIRECT SERVICE NETWORK *****
 For exclusive use by: HENRY ALFONZO

V 6.08
 PAGE 23

Zone #	#Duplic Flr	Zn	Flr/Zn	TotFlr	Part	Xflr	Skyl	%Sk	Roof	Glass	%Gl	Wall
298	1	1	1557	1557	0	1557	0	0	0	0	0	0
300	1	1	1130	1130	0	1130	0	0	0	172	35	306
302	1	1	105	105	0	105	0	0	0	0	0	0
304	1	1	158	158	0	158	0	0	0	0	0	0
306	1	1	562	562	0	562	0	0	0	0	0	0
308	1	1	189	189	0	189	0	0	0	0	0	0
310	1	1	636	636	0	636	0	0	0	0	0	0
312	1	1	116	116	0	116	0	0	0	0	0	0
314	1	1	67	67	0	67	0	0	0	0	0	0
316	1	1	428	428	0	428	0	0	0	0	0	0
318	1	1	1116	1116	0	1116	0	0	0	172	35	306
320	1	1	131	131	0	131	0	0	0	0	0	0
322	1	1	139	139	0	139	0	0	0	1	0	117
Sys 3				8073	0	8036	0	0	0	426	31	923
324	1	1	807	807	0	807	0	0	0	2	0	578
326	1	1	78	78	0	78	0	0	0	0	0	0
328	1	1	121	121	0	121	0	0	0	0	0	0
330	1	1	209	209	0	209	0	0	0	0	0	0
332	1	1	70	70	0	70	0	0	0	0	0	0
334	1	1	172	172	0	172	0	0	0	0	0	0
336	1	1	86	86	0	86	0	0	0	0	0	0
338	1	1	326	326	0	326	0	0	0	0	0	0
340	1	1	85	85	0	0	0	0	0	0	0	0
342	1	1	304	304	0	0	0	0	0	0	0	0
344	1	1	265	265	0	265	0	0	0	0	0	0
346	1	1	135	135	0	135	0	0	0	0	0	0
350	1	1	1557	1557	0	1557	0	0	0	0	0	0
352	1	1	1557	1557	0	1557	0	0	0	0	0	0
354	1	1	296	296	0	296	0	0	0	0	0	0
356	1	1	420	420	0	420	0	0	0	0	0	0
358	1	1	233	233	0	233	0	0	0	32	32	68
Sys 4				6731	0	6332	0	0	0	34	5	646
360	1	1	910	910	0	0	0	0	0	0	0	0
Sys 5				910	0	0	0	0	0	0	0	0
Tot/Av				22550	0	14368	0	0	0	461	22	1570

30 Series Chillers Performance Summary

Project Name: Untitled
Company Name: Samuel Ravelo

21/11/2003
08:30:55 p.m.

Location	quiروفano
Buyer P.O.	
Date	21/11/2003
Version 2.20	
Unit Size	30GTN190-*6--**
Capacity, Tons	173.0
Compressor Input Power, kw	191.3
Unit Input Power, kw	210.2
Capacity control steps	6
Minimum Capacity, %	14.0
Input kw/Ton	1.215
Unit EER	9.9
Refrigerant	R22
Cooler Data	
Fluid Type	Fresh Water
Fluid Entering Temperature, °F	52.4
Fluid Leaving Temperature, °F	42.0
Fluid Flow Rate, gpm	400.0
Fluid Pressure Drop, ft wg	13.2
Fluid Velocity, ft/s	3.3
Fouling Factor, (hr-sqft-F)/BTU	0.0001
Saturated Suction Temp., °F	
Circuit A	34.7
Circuit B	34.6
Condenser Data	
Entering Air Temp, °F	88.0
Altitude, ft	2900
Saturated Discharge Temp, °F	
Circuit A	122.6
Circuit B	122.7
Saturated Condensing Temp, °F	
Circuit A	121.1
Circuit B	121.2
Refrigerant Subcooling, °F	
Circuit A	26.9
Circuit B	27.0
Total Heat Rejection, Tons	
Circuit A	111.2
Circuit B	111.3
Factory Options	
Condenser Coil	Standard - Aluminum Fin / Copper Tube
Flow Control Type	EXV
Baffles	Standard
Chiller Electrical Data	
Nameplate Voltage, volts	460
Elec. Power Frequency, hertz	60
Power Supply to control circuit, volts	115
Power Supply to control circuit, Phases	1

Anexo 45. Selección del Chiller.

30 Series Chillers Performance Summary

Project Name: Untitled
Company Name: Samuel Ravelo

21/11/2003
08:30:55 p.m.

Minimum circuit Amps	368
MOCP	400
Maximum Instantaneous Current Flow ,amps	631
Control Circuit Fuse Amps	30

ARI Rating Ratings outside the scope of
ARI Std 550/590-98

AHU Selection Program Performance Summary (Chilled Water)

Project Name: Untitled

11/11/2003

Prepared by : Samuel Ravelo

11:41:07 p.m.

Air Handler Unit: 39L

Tag Name: SALA PARTO

Cooling Application's Balance Criteria: Leaving Air DB

Coil Model _____	NA
Unit Size _____	6
Row / FPI / Circ _____	6 / 14 / HF
Face Area Type _____	Large
Coil Face Area _____	5.90 sqft
Face Velocity _____	505.1 fpm
Fin/Tube Material _____	Al / Cu
Tube Wall Thickness _____	0.016 in
Site Airflow Rate _____	2980 CFM
Site Altitude _____	2900 ft
Standard Airflow Rate _____	2681 CFM
Total Cooling Capacity _____	217.40 MBH
Sensible Cooling Capacity _____	105.52 MBH
Fluid Flow Rate _____	38.2 gpm
Fluid Pressure Drop _____	22.1 ft wg
Fluid Velocity _____	6.5 ft/s
Entering Fluid Temperature _____	42.00 °F
Leaving Fluid Temperature _____	53.39 °F
Fluid Temperature Rise _____	11.4 °F
Cv Rating _____	12.3
Entering Air Dry Bulb _____	88.00 °F
Entering Air Wet Bulb _____	74.60 °F
Entering Air Enthalpy _____	40.32 BTU/lb
Leaving Air Dry Bulb _____	52.00 °F
Leaving Air Wet Bulb _____	51.85 °F
Leaving Air Enthalpy _____	22.3 BTU/lb
Bypass Factor _____	0.0250
Air Friction _____	0.87 in wg
Brine _____	FW
Brine Concentration _____	0 %

Coil Part Number: 28NA*620HCA086-?

AHU Selection Program Performance Summary (Supply Fan)

Project Name: Untitled
 Prepared by : Samuel Ravelo

11/11/2003
 11:44:59 p.m.

Air Handler Unit: 39L

Tag Name: SALA PARTO

Unit Size **6**
 Fan Type **LA (For LFA Clg. Coils)**
 Inlet Guide Vanes **No**

Acoustic Data:

	Discharge	Inlet	Casing
63 Hz	90	82	84
125 Hz	91	73	79
250 Hz	86	67	69
500 Hz	85	65	65
1000 Hz	84	67	68
2000 Hz	77	66	64
4000 Hz	73	60	60
8000 Hz	68	52	58

Actual Airflow, CFM **2980**
 Site Altitude, ft **2900**
 Standard Airflow, CFM **2681**
 External Static, in wg **1.50**
 Cooling Coil Static, in wg **0.87**
 Heating Coil Static, in wg **0.50**
 Total Accessory Static, in wg **0.00**
 Total Static Pressure, in wg **2.87**
 Fan RPM **1389**
 Fan Brake Power, BHP **2.3**

Accessories:

None

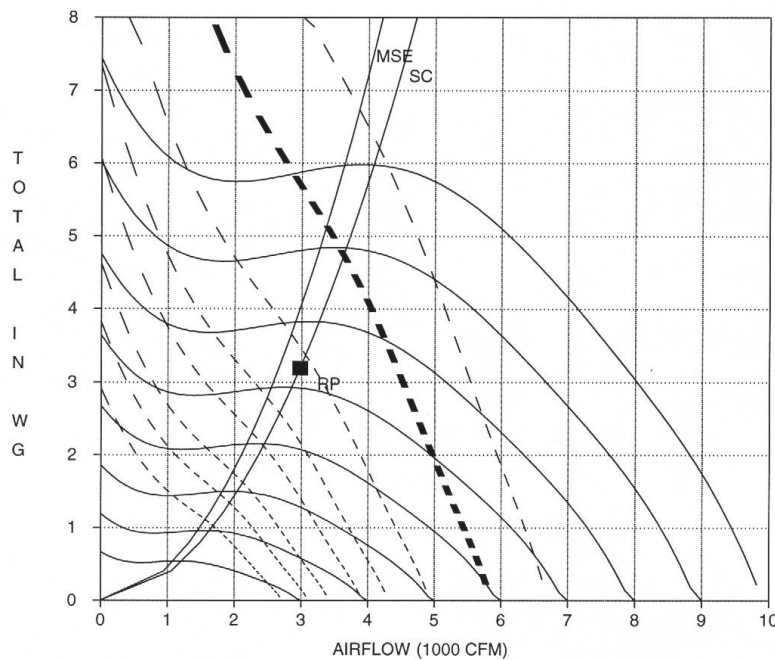

Legend:

- RPM - BHP MSE - Max. Static Eff. SC - System Curve RP - Rated Point

Maximum RPM = 2000 Maximum BHP = 5.0
 RPM's (x 100, Top to Bottom): 20 18 16 14 12 10 8 6
 BHP's (Left to Right): 0.5 0.8 1 1.5 2 3 5 7.5

AHU Selection Program Performance Summary (Chilled Water)

Project Name: Untitled

21/11/2003

Prepared by : Samuel Ravelo

07:55:07 p.m.

Air Handler Unit: 39L

Tag Name: SECTOR ESTE

Cooling Application's Balance Criteria: Fluid Flow

Coil Model _____	NA
Unit Size _____	15
Row / FPI / Circ _____	4 / 14 / FL
Face Area Type _____	Large
Coil Face Area _____	14.90 sqft
Face Velocity _____	457.4 fpm
Fin/Tube Material _____	Al / Cu
Tube Wall Thickness _____	0.016 in
Site Airflow Rate _____	6815 CFM
Site Altitude _____	2900 ft
Standard Airflow Rate _____	6130 CFM
Total Cooling Capacity _____	186.17 MBH
Sensible Cooling Capacity _____	110.50 MBH
Fluid Flow Rate _____	22.0 gpm
Fluid Pressure Drop _____	0.6 ft wg
Fluid Velocity _____	1.2 ft/s
Entering Fluid Temperature _____	42.00 °F
Leaving Fluid Temperature _____	58.92 °F
Fluid Temperature Rise _____	16.9 °F
Cv Rating _____	9.8
Entering Air Dry Bulb _____	77.50 °F
Entering Air Wet Bulb _____	68.80 °F
Entering Air Enthalpy _____	34.82 BTU/lb
Leaving Air Dry Bulb _____	61.02 °F
Leaving Air Wet Bulb _____	60.42 °F
Leaving Air Enthalpy _____	28.1 BTU/lb
Bypass Factor _____	0.0780
Air Friction _____	0.47 in wg
Brine _____	FW
Brine Concentration _____	0 %

Coil Part Number: 28NA*432FCA136-?

AHU Selection Program Performance Summary (Supply Fan)

Project Name: Untitled
 Prepared by : Samuel Ravelo

21/11/2003
 07:56:23 p.m.

Air Handler Unit: 39L

Tag Name: SECTOR ESTE

Unit Size **15**
 Fan Type **LA (For LFA Clg. Coils)**
 Inlet Guide Vanes **No**

Acoustic Data:

	Discharge	Inlet	Casing
63 Hz	86	78	80
125 Hz	86	68	74
250 Hz	82	63	65
500 Hz	83	63	63
1000 Hz	74	57	58
2000 Hz	69	58	56
4000 Hz	63	50	50
8000 Hz	55	39	45

Actual Airflow, CFM **6815**
 Site Altitude, ft **2900**
 Standard Airflow, CFM **6130**
 External Static, in wg **1.00**
 Cooling Coil Static, in wg **0.47**
 Heating Coil Static, in wg **0.00**
 Total Accessory Static, in wg **0.00**
 Total Static Pressure, in wg **1.47**
 Fan RPM **739**
 Fan Brake Power, BHP **2.6**

Accessories:

None

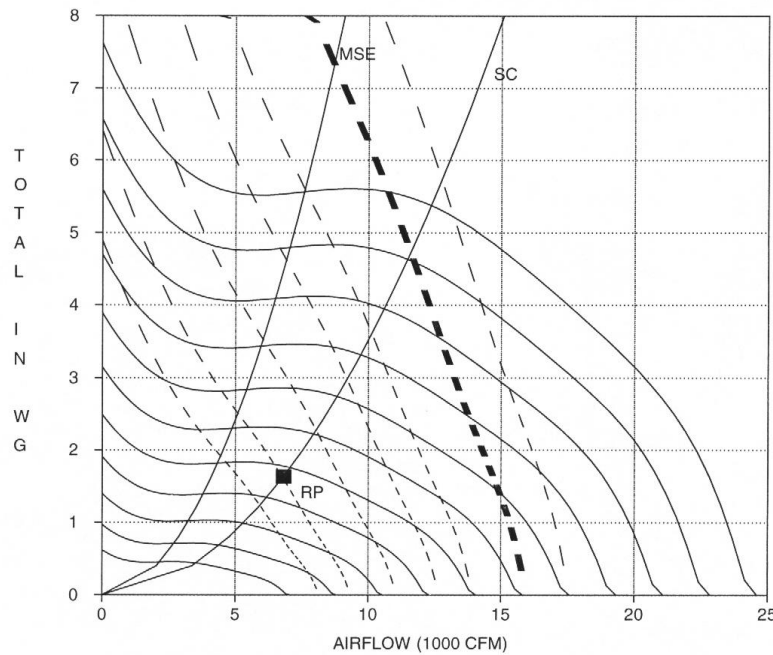

Legend:

- RPM - BHP MSE - Max. Static Eff. SC - System Curve RP - Rated Point

Maximum RPM = 1400 Maximum BHP = 15.0
 RPM's (x 100, Top to Bottom): 14 13 12 11 10 9 8 7 6 5 4
 BHP's (Left to Right): 2 3 5 7.5 10 15 20

AHU Selection Program Performance Summary (Chilled Water)

Project Name: Untitled

11/11/2003

Prepared by : Samuel Ravelo

11:38:24 p.m.

Air Handler Unit: 39L

Tag Name: SECTOR OESTE

Cooling Application's Balance Criteria: Total Cooling

Coil Model _____	NA
Unit Size _____	18
Row / FPI / Circ _____	4 / 14 / FL
Face Area Type _____	Large
Coil Face Area _____	17.70 sqft
Face Velocity _____	500.6 fpm
Fin/Tube Material _____	Al / Cu
Tube Wall Thickness _____	0.016 in
Site Airflow Rate _____	8860 CFM
Site Altitude _____	2900 ft
Standard Airflow Rate _____	7970 CFM
Total Cooling Capacity _____	205.30 MBH
Sensible Cooling Capacity _____	185.30 MBH
Fluid Flow Rate _____	37.4 gpm
Fluid Pressure Drop _____	1.2 ft wg
Fluid Velocity _____	1.7 ft/s
Entering Fluid Temperature _____	42.00 °F
Leaving Fluid Temperature _____	52.99 °F
Fluid Temperature Rise _____	11.0 °F
Cv Rating _____	16.7
Entering Air Dry Bulb _____	75.80 °F
Entering Air Wet Bulb _____	61.80 °F
Entering Air Enthalpy _____	29.01 BTU/lb
Leaving Air Dry Bulb _____	54.54 °F
Leaving Air Wet Bulb _____	53.44 °F
Leaving Air Enthalpy _____	23.3 BTU/lb
Bypass Factor _____	0.0847
Air Friction _____	0.50 in wg
Brine _____	FW
Brine Concentration _____	0 %

Coil Part Number: 28NA*438FCA136-?

AHU Selection Program Performance Summary (Supply Fan)

Project Name: **Untitled**
 Prepared by : **Samuel Ravelo**

11/11/2003
 11:47:30 p.m.

Air Handler Unit: 39L

Tag Name: SECTOR OESTE

Unit Size	18
Fan Type	LA (For LFA Clg. Coils)
Inlet Guide Vanes	No
Actual Airflow, CFM	8860
Site Altitude, ft	2900
Standard Airflow, CFM	7970
External Static, in wg	1.00
Cooling Coil Static, in wg	0.50
Heating Coil Static, in wg	0.00
Total Accessory Static, in wg	0.00
Total Static Pressure, in wg	1.50
Fan RPM	660
Fan Brake Power, BHP	3.9

Acoustic Data:

	Discharge	Inlet	Casing
63 Hz	88	80	82
125 Hz	89	71	77
250 Hz	84	65	67
500 Hz	85	65	65
1000 Hz	76	59	60
2000 Hz	70	59	57
4000 Hz	64	51	51
8000 Hz	56	40	46

Accessories:

None

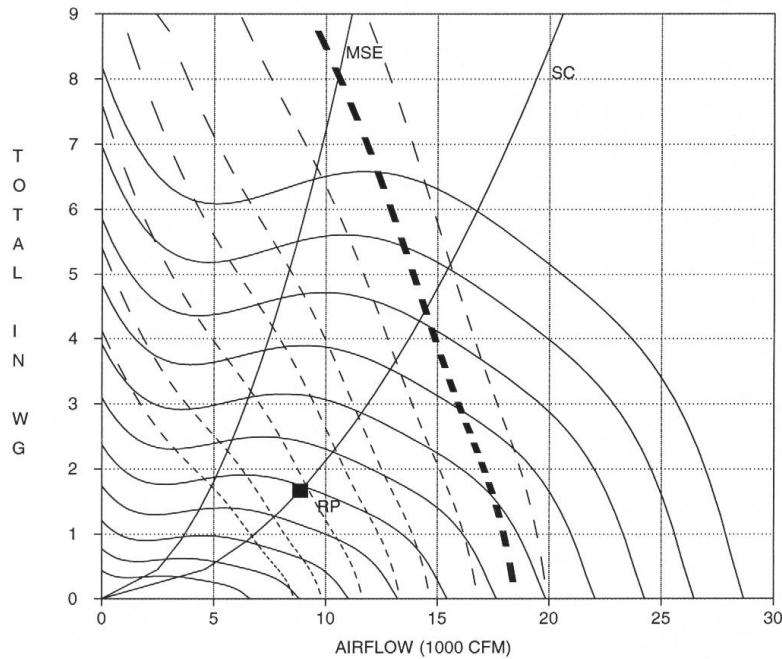

Legend:

- RPM - BHP MSE - Max. Static Eff. SC - System Curve RP - Rated Point

Maximum RPM = 1300 Maximum BHP = 20.0
 RPM's (x 100, Top to Bottom): 13 12 11 10 9 8 7 6 5 4 3
 BHP's (Left to Right): 2 3 5 7.5 10 15 20 25

AHU Selection Program Performance Summary (Chilled Water)

Project Name: Untitled

11/11/2003

Prepared by : Samuel Ravelo

11:31:55 p.m.

Air Handler Unit: 39L

Tag Name: QUIROFANOS (J al P)

Cooling Application's Balance Criteria: Leaving Air DB

Coil Model _____	NA
Unit Size _____	25
Row / FPI / Circ _____	6 / 14 / FL
Face Area Type _____	Large
Coil Face Area _____	25.00 sqft
Face Velocity _____	475.4 fpm
Fin/Tube Material _____	Al / Cu
Tube Wall Thickness _____	0.016 in
Site Airflow Rate _____	11885 CFM
Site Altitude _____	2900 ft
Standard Airflow Rate _____	10691 CFM
Total Cooling Capacity _____	866.69 MBH
Sensible Cooling Capacity _____	420.85 MBH
Fluid Flow Rate _____	145.7 gpm
Fluid Pressure Drop _____	15.2 ft wg
Fluid Velocity _____	5.6 ft/s
Entering Fluid Temperature _____	42.00 °F
Leaving Fluid Temperature _____	53.89 °F
Fluid Temperature Rise _____	11.9 °F
Cv Rating _____	56.6
Entering Air Dry Bulb _____	88.00 °F
Entering Air Wet Bulb _____	74.60 °F
Entering Air Enthalpy _____	40.32 BTU/lb
Leaving Air Dry Bulb _____	52.00 °F
Leaving Air Wet Bulb _____	51.86 °F
Leaving Air Enthalpy _____	22.3 BTU/lb
Bypass Factor _____	0.0230
Air Friction _____	0.79 in wg
Brine _____	FW
Brine Concentration _____	0 %

Coil Part Number: (2) & 28NA*622FCA166-?

AHU Selection Program Performance Summary (Supply Fan)

Project Name: Untitled
 Prepared by : Samuel Ravelo

11/11/2003
 11:46:31 p.m.

Air Handler Unit: 39L

Tag Name: QUIROFANOS (J al P)

Unit Size	25
Fan Type	LA (For LFA Clg. Coils)
Inlet Guide Vanes	No
Actual Airflow, CFM	11885
Site Altitude, ft	2900
Standard Airflow, CFM	10691
External Static, in wg	1.50
Cooling Coil Static, in wg	0.79
Heating Coil Static, in wg	0.50
Total Accessory Static, in wg	0.00
Total Static Pressure, in wg	2.79
Fan RPM	695
Fan Brake Power, BHP	8.0

Acoustic Data:

	Discharge	Inlet	Casing
63 Hz	92	84	86
125 Hz	92	74	80
250 Hz	88	69	71
500 Hz	88	68	68
1000 Hz	78	61	62
2000 Hz	72	61	59
4000 Hz	65	52	52
8000 Hz	56	40	46

Accessories:

None

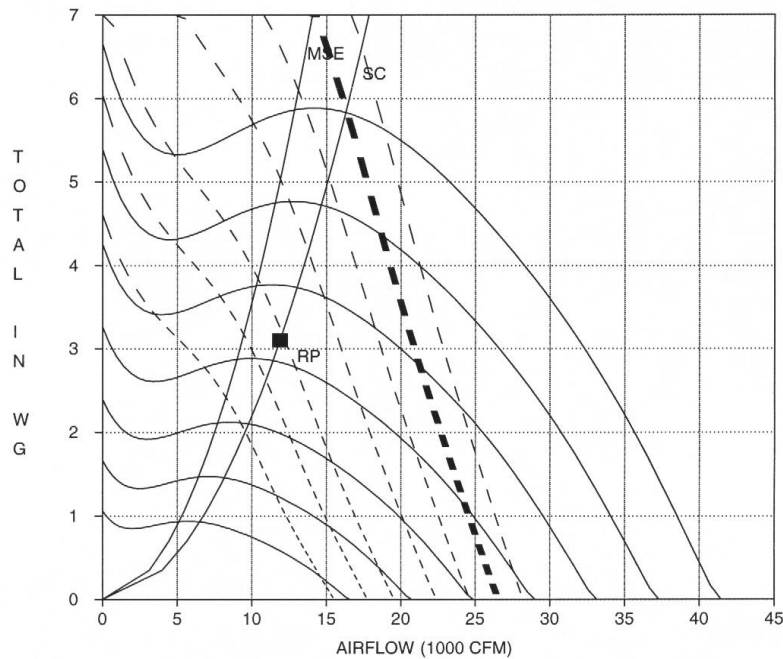

Legend:

- RPM - BHP MSE - Max. Static Eff. SC - System Curve RP - Rated Point

Maximum RPM = 1000 Maximum BHP = 25.0

RPM's (x 100, Top to Bottom): 10 9 8 7 6 5 4

BHP's (Left to Right): 5 7.5 10 15 20 25 30

AHU Selection Program Performance Summary (Chilled Water)

Project Name: Untitled

11/11/2003

Prepared by : Samuel Ravelo

11:30:29 p.m.

Air Handler Unit: 39L

Tag Name: QUIROFANOS (A al I)

Cooling Application's Balance Criteria: Leaving Air DB

Coil Model _____	NA
Unit Size _____	25
Row / FPI / Circ _____	6 / 14 / FL
Face Area Type _____	Large
Coil Face Area _____	25.00 sqft
Face Velocity _____	491.8 fpm
Fin/Tube Material _____	Al / Cu
Tube Wall Thickness _____	0.016 in
Site Airflow Rate _____	12295 CFM
Site Altitude _____	2900 ft
Standard Airflow Rate _____	11060 CFM
Total Cooling Capacity _____	896.79 MBH
Sensible Cooling Capacity _____	435.37 MBH
Fluid Flow Rate _____	156.1 gpm
Fluid Pressure Drop _____	17.3 ft wg
Fluid Velocity _____	6.0 ft/s
Entering Fluid Temperature _____	42.00 °F
Leaving Fluid Temperature _____	53.49 °F
Fluid Temperature Rise _____	11.5 °F
Cv Rating _____	57.0
Entering Air Dry Bulb _____	88.00 °F
Entering Air Wet Bulb _____	74.60 °F
Entering Air Enthalpy _____	40.32 BTU/lb
Leaving Air Dry Bulb _____	52.00 °F
Leaving Air Wet Bulb _____	51.85 °F
Leaving Air Enthalpy _____	22.3 BTU/lb
Bypass Factor _____	0.0241
Air Friction _____	0.83 in wg
Brine _____	FW
Brine Concentration _____	0 %

Coil Part Number: (2) & 28NA*622FCA166-?

AHU Selection Program Performance Summary (Supply Fan)

Project Name: **Untitled**

11/11/2003

Prepared by : **Samuel Ravelo**

11:45:51 p.m.

Air Handler Unit: 39L

Tag Name: QUIROFANOS (A al I)

Unit Size **25**

Fan Type **LA (For LFA Clg. Coils)**

Inlet Guide Vanes **No**

Actual Airflow, CFM **12295**

Site Altitude, ft **2900**

Standard Airflow, CFM **11060**

External Static, in wg **1.50**

Cooling Coil Static, in wg **0.83**

Heating Coil Static, in wg **0.50**

Total Accessory Static, in wg **0.00**

Total Static Pressure, in wg **2.83**

Fan RPM **702**

Fan Brake Power, BHP **8.5**

Acoustic Data:

	Discharge	Inlet	Casing
63 Hz	93	85	87
125 Hz	93	75	81
250 Hz	88	69	71
500 Hz	89	69	69
1000 Hz	79	62	63
2000 Hz	73	62	60
4000 Hz	66	53	53
8000 Hz	56	40	46

Accessories:

None

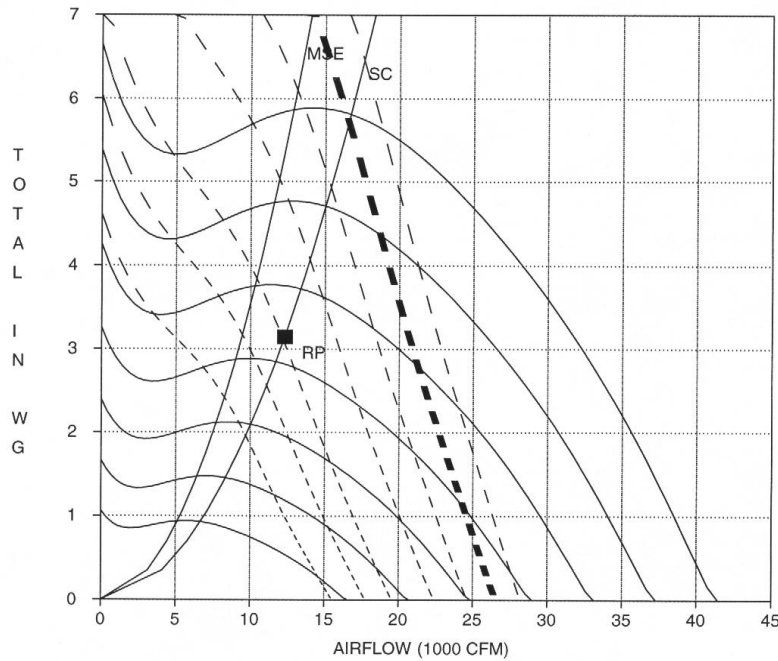

Legend:

- RPM - BHP MSE - Max. Static Eff. SC - System Curve RP - Rated Point

Maximum RPM = 1000 Maximum BHP = 25.0

RPM's (x 100, Top to Bottom): 10 9 8 7 6 5 4

BHP's (Left to Right): 5 7.5 10 15 20 25 30

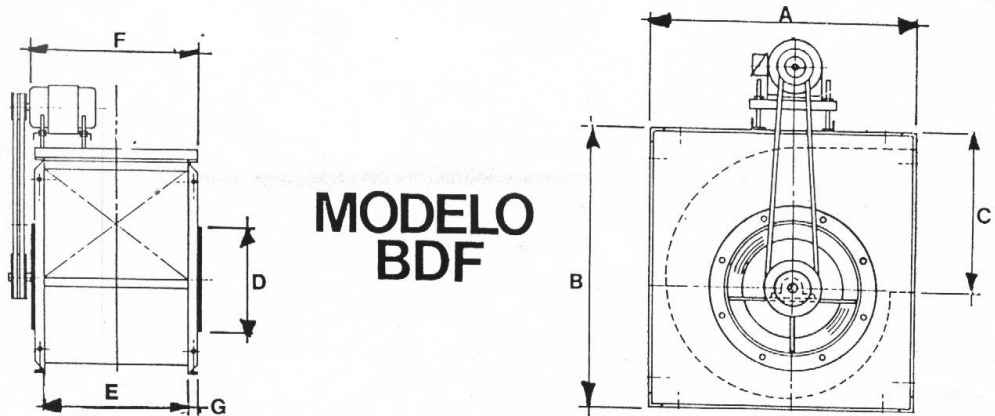

MODELO BDF

MEDIDAS CONSTRUCTIVAS EN MILIMETROS

MODELO	A	B	C	D	E	F	G
12	565	622	315	330	400	480	40
14	630	724	395	381	400	480	40
16	724	850	465	431	500	580	40
20	927	1034	550	533	640	740	50
24	1060	1240	680	635	770	780	50
30	1280	1524	780	787	1000	1135	65
36	1600	1820	980	939	1180	1310	65

NOTA: Todas las medidas son aproximadas.

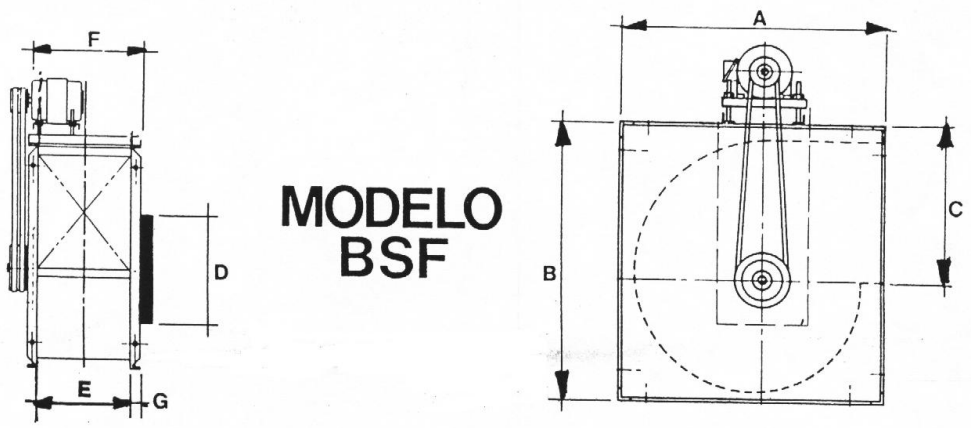

MODELO BSF

MEDIDAS CONSTRUCTIVAS EN MILIMETROS

MODELO	A	B	C	D	E	F	G
12	565	622	315	330	200	280	40
14	630	724	395	381	200	280	40
16	724	850	465	431	255	335	40
20	927	1034	550	533	320	420	50
24	1060	1240	680	635	385	485	50
30	1280	1524	780	787	500	630	65
36	1600	1820	980	939	590	720	65

NOTA: Todas las medidas son aproximadas.

Anexo 51. Selección de los Extractores.

***** CUSTOMER DIRECT SERVICE NETWORK *****

For exclusive use by: Trane Customer Direct Service Network

WATER PIPING PROGRAM

PROGRAM VERSION: 8.08 RUN DATE: 11/24/03

INPUT DATA

PROJECT : SISTEMA DE RECIRCULACION DE AGUA
 LOCATION : QUIROFANOS/S
 OWNER :
 USER :
 COMMENTS :

PIPE TYPE	FLUID	TEMP	CONC	VISCOSITY	SPECIFIC GRAVITY	ROUGHNESS	MAX TPD	EXISTING SYSTEM	INSULATE PIPE	COST SYSTEM
S	W	42	0	1.487	1.001	0.00015	0.0	YES	NO	NO

NODE #1	NODE #2	LENGTH FEET	FLOW GPM	COIL PD	ELBOWS			FITTINGS			ACT DIA	MAX VEL	MAX PD	VLV CV	ELV 1	ELV 2	
					SHORT	GATE	ANGLE	STR	LONG	GLOBE							CHECK
1	2	164	400.0	13.2	0	12	4	1	0	1	1	4.0	20.0	10.0	0.0	0	0
2	3	10	362.0	0.0	0	0	0	0	0	0	0	4.0	20.0	10.0	0.0	0	0
3	4	16	302.0	0.0	0	2	1	0	0	0	0	4.0	20.0	10.0	0.0	0	0
4	7	230	146.0	15.2	0	4	2	1	0	0	0	3.0	20.0	10.063	0.0	0	0
4	7	55	156.0	17.3	0	4	2	1	0	0	0	3.0	20.0	10.063	0.0	0	0
3	5	8	60.0	0.0	0	1	1	0	0	0	0	2.5	20.0	10.0	0.0	0	0
5	6	20	22.0	0.6	0	3	2	1	0	0	0	2.0	20.0	10.025	0.0	0	0
5	6	262	38.0	1.2	0	8	2	1	0	0	0	2.0	20.0	10.025	0.0	0	0
2	9	32	38.0	22.1	0	6	2	1	0	0	0	2.0	20.0	10.025	0.0	0	0
6	8	8	60.0	0.0	0	1	1	0	0	0	0	2.5	20.0	10.0	0.0	0	0
7	8	16	302.0	0.0	0	2	1	0	0	0	0	4.0	20.0	10.0	0.0	0	0
8	9	10	362.0	0.0	0	0	0	0	0	0	0	4.0	20.0	10.0	0.0	0	0
9	1	164	400.0	0.0	0	12	0	0	0	0	0	4.0	20.0	10.0	0.0	0	0

MORE THAN ONE COIL IN A PATH. VERIFY GPM.

OUTPUT DATA:

NODE #1	NODE #2	GPM	VELOCITY	NOMINAL DIAMETER	TOTAL PD	PIPE PD	COIL PD	VALVE PD	ELEV PD	
*	1	2	400.0	10.08	4	57.37	44.17	13.20	0.00	0
*	2	3	362.0	9.12	4	1.23	1.23	0.00	0.00	0
*	3	4	302.0	7.61	4	2.10	2.10	0.00	0.00	0
*	4	7	146.0	6.34	3	46.40	18.80	15.20	12.40	0
	4	7	156.0	6.77	3	42.68	11.23	17.30	14.16	0
	3	5	60.0	4.02	2 1/2	0.54	0.54	0.00	0.00	0
	5	6	22.0	2.10	2	3.57	1.18	0.60	1.79	0
	5	6	38.0	3.63	2	17.39	10.86	1.20	5.33	0
	2	9	38.0	3.63	2	31.00	3.57	22.10	5.33	0
	6	8	60.0	4.02	2 1/2	0.54	0.54	0.00	0.00	0
*	7	8	302.0	7.61	4	2.10	2.10	0.00	0.00	0
*	8	9	362.0	9.12	4	1.23	1.23	0.00	0.00	0
*	9	1	400.0	10.08	4	22.04	22.04	0.00	0.00	0

* DENOTES CRITICAL RUN

LOOP PRESSURE DROPS

TPD	NODE LIST							
110.42	1c	2c	9	1				
100.36	1c	2	3	5c	6	8	9	1
86.53	1c	2	3	5c	6	8	9	1
128.77	1c	2	3	4c	7	8	9	1
* 132.49	1c	2	3	4c	7	8	9	1

Anexo 52. Selección de las Tuberías de Agua y Accesorios.

BILL OF MATERIALS

PIPE SIZE	FEET	SHORT ELBOW	LONG ELBOW	GATE	GLOBE	ANGLE	CHECK	STRAINER
2	314	0	17	6	3	0	0	0
2 1/2	16	0	2	2	0	0	0	0
3	285	0	8	4	2	0	0	0
4	380	0	28	6	1	0	1	1

TEES

QUANTITY	DIA 1	DIA 2	DIA 3	DIA 4
2	4	3	3	
2	4	4	2	
2	4	4	2 1/2	
2	2 1/2	2	2	

457.23 GALLONS OF FLUID. (DOES NOT INCLUDE COILS OR HEAT EXCHANGERS)

Tag Num	Qty
0	1

Service: HOSPITAL
Location:

Motor Info

Voltage	Phase	Cycles	Motor Size	Enclosure	Efficiency
460	3	60	25 hp	ODP	Std

Inverter Duty

Series: 4030, 4x3x11.5, BF (Bronze Fitted)
 Flow: 400.0 usgpm, Head: 133.0 ft, Impeller dia: 11.68 in
 Pump Speed: 1750 rpm, Efficiency: 73.59 %, BHP: 18.26 hp
 Motor Size: 25 hp, Motor Speed: 1800

Anexo 53. Selección de la Bomba.

ARMSTRONG Series 4030
 4x3x11.5
 Centerline Disc. End Suction Basemounted Pump

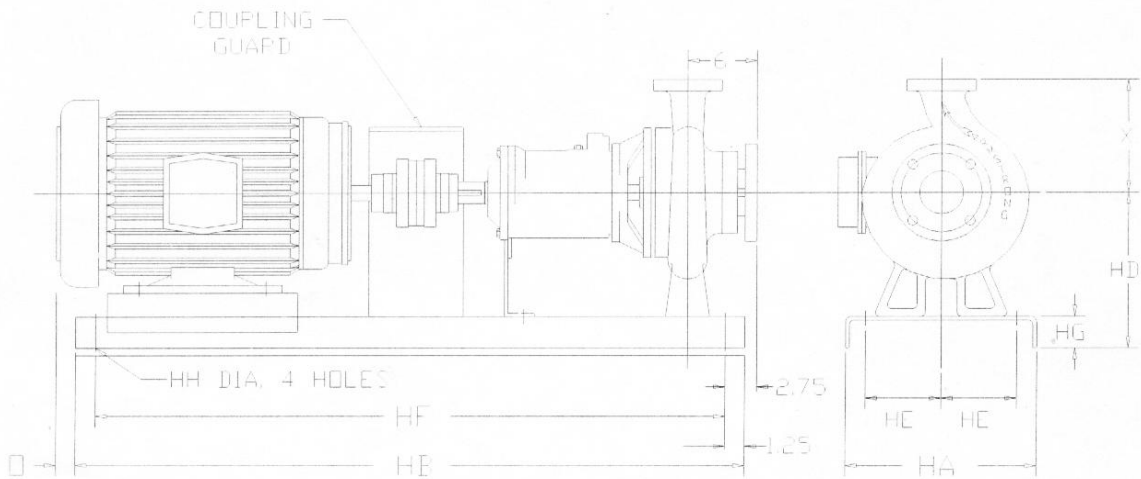

Dimensional Data

.....Pump.....			
Pump	4x3x11.5	Frame	284
Encl.	ODP	HA	18.00 in
HB	48.00 in	HD	12.25 in
HE	4.88 in	HF	45.50 in
HG	4.00 in	HH	1.00 in
X	11.00 in	Wgt.	210.0 lbs
Wgt.	250.0 lbs		

ARMSTRONG Series 4030

4x3x11.5
Centerline Disc. End Suction Basemounted Pump

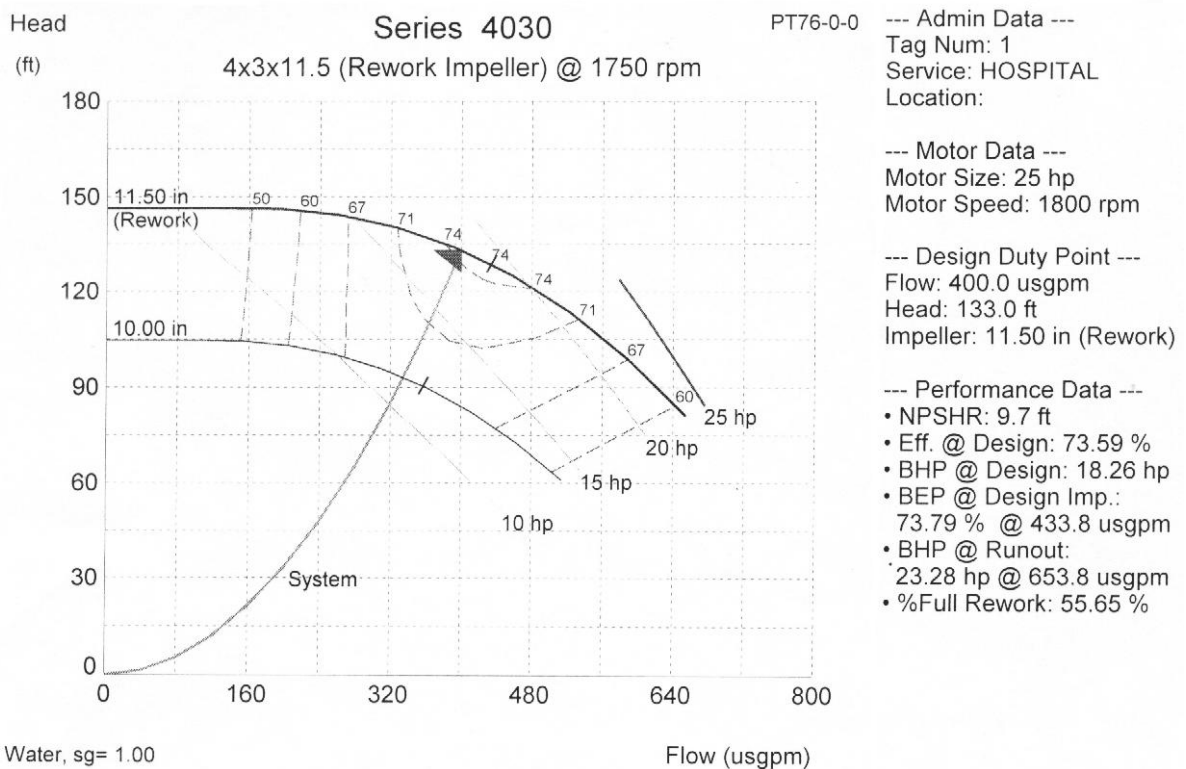

PRESUPUESTO DE OBRA No. :				2011-01			
SEÑORES: HOSPITAL PÉREZ CARREÑO				FECHA			
ATN :				CIUDAD	DIA	MES	AÑO
OBRA : SISTEMA DE AIRE ACONDICIONADO Y VENTILACIONES MECÁNICAS PISO 4 SALAS DE QUIRÓFANO Y SALA DE PARTO.				Caracas	20	11	2003
				PAGINA # : 1 DE 8			
PARTIDA No.	DESCRIPCIÓN	UNID.	CANT.	PRECIOS			
				UNITARIO	TOTAL		
01	Suministro de Enfriador de agua del tipo compacto, con condensación por aire, compresores Reciprocante, marca CARRIER o similar, modelo 30GTN190, con capacidad para 166 toneladas de refrigeración, temperatura del agua de salida de 42°F y temperatura de condensación de 88°F, con voltaje de operación de 460/3/60.	Pza.	1,00	164.424.000,00	164.424.000,00		
02	Instalación de Enfriador del tipo compacto, trabajo que incluye: * Transporte e Izamiento de Unidad enfriadora por medio de Grúa telescópica. * Colocación en sitio de enfriadores sobre durmientes o base de concreto previamente elaborado por obras civiles. * Conexión eléctrica de la Unidad a tablero de control y conexión a red de tubería de agua helada.	Pza.	1,00	27.404.000,00	27.404.000,00		
03	Suministro de Bombas centrifugas, del tipo succión por un extremo, para el manejo de 400 GPM, para vencer una presión total del sistema 133 pies de agua, con motor de 25 HP a una velocidad de giro 1750 RPM operando en 460/3/60.	Pza.	2,00	3.000.000,00	6.000.000,00		
04	Instalación de Bombas centrifugas, trabajos que * Transporte y colocación en sitio de las unidades sobre base de inercia. * Conexión eléctrica de la unidad y conexión a red de tubería de recirculación. * No incluye caseta de protección.	Pza.	2,00	625.000,00	1.250.000,00		
SUB - TOTAL I. Bs.					199.078.000,00		
SUB - TOTAL ACUMULADO Bs.					199.078.000,00		
PRESUPUESTADO POR:				APROBADO POR:			

Anexo 54. Presupuesto del Proyecto.

PRESUPUESTO DE OBRA No. :				2011-01			
SEÑORES: HOSPITAL PÉREZ CARREÑO				FECHA			
ATN :				CIUDAD	DIA	MES	AÑO
OBRA : SISTEMA DE AIRE ACONDICIONADO Y VENTILACIONES MECÁNICAS PISO 4 SALAS DE QUIRÓFANO Y SALA DE PARTO.				Caracas	20	11	2003
				PAGINA # : 2 DE 8			
PARTIDA No.	DESCRIPCIÓN	UNID.	CANT.	PRECIOS			
				UNITARIO	TOTAL		
05	Suministro e instalación de Unidades de aire del tipo Industrial Liviana, marca CARRIER o similar, modelo 39L, incluye secciones de prefiltrado y filtrado final, y banco de resistencia eléctrica con voltaje de operación de 460/3/60.						
	UMA No. (Sala Parto) 39LA06, (Eléctrica heating 08 Kw.)	Pza.	1,00	6.795.360,00	6.795.360,00		
	UMA No. (Quirófano A-I) 39LA25, (Eléctrica heating 30 Kw.)	Pza.	1,00	28.310.880,00	28.310.880,00		
	UMA No. (Quirófano J-N) 39LA25, (Eléctrica heating 30 Kw.)	Pza.	1,00	28.310.880,00	28.310.880,00		
	UMA No. (Sector Oeste) 39LD18. UMA No. (Sector Este) 39LD15.	Pza.	1,00	20.382.960,00	20.382.960,00		
		Pza.	1,00	16.985.280,00	16.985.280,00		
06	Suministro e instalación de Ventilador centrifugo liviano simple entrada, para la extracción de quirófanos, marca FREDIVE o similar, modelo BSF-30, para el manejo de 9600 PCM, con motor de 3HP, 725 RPM, 208/3/60.	Pza.	2	3.420.000,00	6.840.000,00		
07	Suministro e instalación de Ventiladores propela de acople directo, para la inyección de aire fresco, marca FREDIVE o similar, modelo AFP-12.	Pza.	2	314.500,00	629.000,00		
08	Suministro e instalación de ducteria metálica de sección rectangular, elaborado en lamina galvanizada, incluye accesorios para su instalación y montaje.	Kg.	13600	4.750,00	64.600.000,00		
09	Suministro e instalación de aislamiento térmico para la ducterías ubicadas en el área interna, elaborado a base de lana de fibra de vidrio, recubierta con papel de aluminio reforzado.	m ²	1650	11.500,00	18.975.000,00		
SUB - TOTAL II. Bs.					191.829.360,00		
SUB - TOTAL ACUMULADO Bs.					390.907.360,00		
PRESUPUESTADO POR:				APROBADO POR:			

PRESUPUESTO DE OBRA No. :				2011-01			
SEÑORES: HOSPITAL PÉREZ CARREÑO				FECHA			
ATN :				CIUDAD	DIA	MES	AÑO
OBRA : SISTEMA DE AIRE ACONDICIONADO Y VENTILACIONES MECÁNICAS PISO 4 SALAS DE QUIRÓFANO Y SALA DE PARTO.				Caracas	20	11	2003
				PAGINA # : 3 DE 8			
PARTIDA No.	DESCRIPCIÓN	UNID.	CANT.	PRECIOS			
				UNITARIO	TOTAL		
10	Suministro e instalación de Rejilla de suministro de doble deflexión, provistas de controles d caudal del tipo d venas opuestas.						
	48" x 14"	Pza.	18,00	156.967,00	2.825.406,00		
	48" x 12"	Pza.	4,00	132.818,00	531.272,00		
	36" x 12"	Pza.	1,00	101.229,00	101.229,00		
	24" x 06"	Pza.	2,00	47.455,00	94.910,00		
11	Suministro e instalación de difusores básicos fabricados en aluminio anodizado, con control de caudal del tipo de venas opuestas.						
	14" x 14" 4V	Pza.	8,00	50.361,00	402.888,00		
	12" x 12" 4V	Pza.	23,00	38.272,00	880.256,00		
	10" x 10" 4V	Pza.	14,00	33.879,00	474.306,00		
	08" x 08" 4V	Pza.	5,00	29.358,00	146.790,00		
12	Suministro e instalación de rejillas para retorno o extracción, de venas fijas y simple deflexión, con control de caudal .						
	RR 28" x 24" s/c	Pza.	3,00	84.661,00	253.983,00		
	RR 24" x 24" s/c	Pza.	9,00	69.778,00	628.002,00		
	RR 24" x 14" c/c	Pza.	38,00	64.162,00	2.438.156,00		
	RR 18" x 12" s/c	Pza.	1,00	29.625,00	29.625,00		
	RR 16" x 16" s/c	Pza.	1,00	32.853,00	32.853,00		
	RR 14" x 14" s/c	Pza.	1,00	28.221,00	28.221,00		
13	Suministro e instalación de termostato de ubicación en ambiente, de accionamiento proporcional, para el control de las válvulas motorizada de las UMAS del Sector Oeste y Este..	Pza.	2,00	1.350.000,00	2.700.000,00		
SUB - TOTAL III. Bs.					11.567.897,00		
SUB - TOTAL ACUMULADO Bs.					402.475.257,00		
PRESUPUESTADO POR:				APROBADO POR:			

PRESUPUESTO DE OBRA No. :				2011-01			
SEÑORES: HOSPITAL PÉREZ CARREÑO				FECHA			
ATN :				CIUDAD	DIA	MES	AÑO
OBRA : SISTEMA DE AIRE ACONDICIONADO Y VENTILACIONES MECÁNICAS PISO 4 SALAS DE QUIRÓFANO Y SALA DE PARTO.				Caracas	20	11	2003
				PAGINA # : 4 DE 8			
PARTIDA No.	DESCRIPCIÓN	UNID.	CANT.	PRECIOS			
				UNITARIO	TOTAL		
14	Suministro e instalación de termostato de ubicación en ambiente, multi Etapa, para el control de los bancos de resistencia eléctrica de las UMAS de Quirófano y sala de parto.	Pza.	3,00	1.450.000,00	4.350.000,00		
15	Suministro e instalación de Humidistato, para el control de las válvulas motorizada de las UMAS del quirófanos y sala de parto, incluye sensor y caja protectora.	Pza.	3,00	1.950.000,00	5.850.000,00		
16	Suministro e instalación de Válvulas de Control del tipo tres vías, con motor de accionamiento proporcional, con resorte al retorno al desenergizarse la válvula, según especificaciones y planos.						
	ø 2 1/2" CV 63	Pza.	2,00	2.925.000,00	5.850.000,00		
	ø 1 1/2 CV 25	Pza.	3,00	1.989.000,00	5.967.000,00		
17	Suministro e instalación de Válvulas de balanceo Circuit Setter, según especificaciones y planos.						
	ø 2 1/2"	Pza.	2,00	1.942.200,00	3.884.400,00		
	ø 1 1/2"	Pza.	3,00	1.755.000,00	5.265.000,00		
18	Suministro e instalación de válvulas tipo Mariposa, según especificaciones y planos.						
	ø 4"	Pza.	6,00	678.060,00	4.068.360,00		
	ø 3"	Pza.	4,00	645.615,00	2.582.460,00		
	ø 2 1/2"	Pza.	2,00	624.960,00	1.249.920,00		
SUB - TOTAL IV. Bs.					39.067.140,00		
SUB - TOTAL ACUMULADO Bs.					441.542.397,00		
PRESUPUESTADO POR:				APROBADO POR:			

PRESUPUESTO DE OBRA No. :				2011-01			
SEÑORES: HOSPITAL PÉREZ CARREÑO				FECHA			
ATN :				CIUDAD	DÍA	MES	AÑO
OBRA : SISTEMA DE AIRE ACONDICIONADO Y VENTILACIONES MECÁNICAS PISO 4 SALAS DE QUIRÓFANO Y SALA DE PARTO.				Caracas	20	11	2003
				PAGINA # :		5	DE 8
PARTIDA No.	DESCRIPCIÓN	UNID.	CANT.	PRECIOS			
				UNITARIO	TOTAL		
19	Suministro e instalación de Válvulas tipo Compuerta, según especificaciones y planos.						
	Ø 2"	Pza	6,00	66.002,00	396.012,00		
	Ø 3/4"	Pza	2,00	18.153,00	36.306,00		
20	Suministro e instalación de Válvula tipo bola, según especificaciones y planos.						
	Ø 4"	Pza.	1,00	369.000,00	369.000,00		
21	Suministro e instalación de tubería en hierro negro Schedule 40, para la recirculación del agua helada, incluyendo todos sus accesorios para su instalación y montaje.						
	Ø 4"	ml	116,00	108.552,00	12.592.032,00		
	Ø 3"	ml	86,00	76.265,00	6.558.790,00		
	Ø 2 1/2"	ml	6,00	58.450,00	350.700,00		
	Ø 2"	ml	96,00	36.750,00	3.528.000,00		
	Ø 3/4"	ml	6,00	13.650,00	81.900,00		
22	Suministro e instalación de aislamiento térmico para la tubería de agua helada internas a base de conchas de poliestireno, recubierto con protecapa, según especificaciones y planos.						
	Ø 4"	ml	116,00	13.000,00	1.508.000,00		
	Ø 3"	ml	86,00	10.150,00	872.900,00		
	Ø 2 1/2"	ml	6,00	7.325,00	43.950,00		
	Ø 2"	ml	96,00	7.325,00	703.200,00		
	Ø 3/4"	ml	6,00	3.000,00	18.000,00		
SUB - TOTAL V. Bs.						27.058.790,00	
SUB - TOTAL ACUMULADO Bs.						468.601.187,00	
PRESUPUESTADO POR:				APROBADO POR:			

SEÑORES: HOSPITAL PÉREZ CARREÑO				PRESUPUESTO DE OBRA No. : 2011-01			
ATN :				FECHA			
OBRA : SISTEMA DE AIRE ACONDICIONADO Y VENTILACIONES MECÁNICAS PISO 4 SALAS DE QUIRÓFANO Y SALA DE PARTO.				CIUDAD	DIA	MES	AÑO
				Caracas	20	11	2003
				PAGINA # :		6	DE 8
PARTIDA No.	DESCRIPCIÓN	UNID.	CANT.	PRECIOS			
				UNITARIO	TOTAL		
23	Suministro e instalación de juntas flexibles, según especificaciones y planos. ø 4"	Pza.	6,00	509.400,00	3.056.400,00		
24	Suministro e instalación de válvulas de retención (check), según especificaciones y planos. ø 4"	Pza.	2,00	601.200,00	1.202.400,00		
25	Suministro e instalación de Filtros cedazo tipo "Y", según especificaciones y planos. ø 4"	Pza.	2,00	1.134.000,00	2.268.000,00		
26	Suministro e instalación de manómetros incluyendo espita para su instalación, según especificaciones y planos.	Pza.	6	238.680,00	1.432.080,00		
27	Suministro e instalación de termómetros, incluyendo termoposo, para su instalación y montaje, según especificaciones y planos.	Pza.	2	210.600,00	421.200,00		
28	Suministro e instalación de Sensor de Flujo Flow Switch.	Pza.	1	477.000,00	477.000,00		
29	Suministro e instalación de Tanque de expansión abierto con capacidad mínima de 100 LTS, incluyendo todos sus accesorios para su instalación y montaje, según planos y especificaciones.	Pza.	1	395.000,00	395.000,00		
30	Suministro e instalación de Ventosas automáticas ø 3/4".	Pza.	2	265.200,00	530.400,00		
SUB - TOTAL VI. Bs.					9.782.480,00		
SUB - TOTAL ACUMULADO Bs.					478.383.667,00		
PRESUPUESTADO POR:				APROBADO POR:			

PRESUPUESTO DE OBRA No. :				2011-01			
SEÑORES: HOSPITAL PÉREZ CARREÑO				FECHA			
ATN :				CIUDAD	DIA	MES	AÑO
OBRA : SISTEMA DE AIRE ACONDICIONADO Y VENTILACIONES MECÁNICAS PISO 4 SALAS DE QUIRÓFANO Y SALA DE PARTO.				Caracas	20	11	2003
				PAGINA # :	7	DE	8
PARTIDA No.	DESCRIPCIÓN	UNID.	CANT.	PRECIOS			
				UNITARIO	TOTAL		
31	Suministro e instalación de juego de amortiguadores, para las unidades centrales de enfriamiento , según especificaciones y planos, (Incluye el izamiento de las unidades para efectuar el montaje de los mismos). Juego de 6	Kit	1	1.750.000,00	1.750.000,00		
32	Suministro e Instalación de Juego de aisladores de vibración y base de inercia, para las Bombas Centrifugas, según especificaciones.	Kit	2	950.000,00	1.900.000,00		
33	Suministro e instalación de tuberías de PVC ø 3/4", para el drenaje de las unidades, incluye sifón, hasta una distancia no mayor a 3 metros del punto de drenaje dejado por obras civiles.	ml	30	12.500,00	375.000,00		
34	Suministro e instalación de Filtros tipo Hepa 99.97% de 24" x 24" x 24" (Filtrado final)	Pzxa.	14	1.745.900,00	24.442.600,00		
35	Suministro e instalación de Filtros de Bolsa de 6 bolsillos, con eficiencia 90-95%, de 24" x 24" x 24". (pre filtro)	Pza.	18	129.600,00	2.332.800,00		
36	Suministro e instalación de Filtros tipo plisado con eficiencia 35-40%, de 24" x 24" x 2". (pre filtro)	Pza.	18	71.100,00	1.279.800,00		
SUB - TOTAL VII. Bs.					32.080.200,00		
SUB - TOTAL ACUMULADO Bs.					510.463.867,00		
PRESUPUESTADO POR:				APROBADO POR:			

SEÑORES: HOSPITAL PÉREZ CARREÑO				PRESUPUESTO DE OBRA No. : 2011-01			
ATN :				FECHA			
OBRA : SISTEMA DE AIRE ACONDICIONADO Y VENTILACIONES MECÁNICAS PISO 4 SALAS DE QUIRÓFANO Y SALA DE PARTO.				CIUDAD	DIA	MES	AÑO
				Caracas	20	11	2003
				PAGINA # : 8 DE 8			
PARTIDA No.	DESCRIPCIÓN	UNID.	CANT.	PRECIOS			
				UNITARIO	TOTAL		
37	Suministro e instalación de material eléctrico, para la interconexión de los equipos a su punto de fuerza y control, hasta una distancia no mayor a 3 metros del punto de fuerza dejado por el contratista eléctrico. Incluye tablero para alojamiento de breakers, selector de arranque y parada y luces indicadoras.	Equipo	7	325.000,00	2.275.000,00		
38	Suministro e instalación de Tableros Centrales de Control, para el arranque de Enfriadores y bombas , el mismo deberá contener arrancadores, breakers, protección para motores, botones o perillas de tres posiciones y luces indicadoras, según especificaciones y planos.	Pza.	1	2.015.315,00	2.015.315,00		
39	Ingeniería, Prueba, arranque y balanceo del sistema.	kit	1	750.000,00	750.000,00		
SUB - TOTAL VIII. Bs.					5.040.315,00		
TOTAL PRESUPUESTADO Bs.					515.504.182,00		
PRESUPUESTADO POR:				APROBADO POR:			

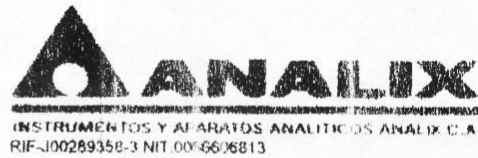
**COTIZACIÓN****N°7874****CARACAS 08/10/2003****HOJA: 1/1****Sres. HOSPITAL PÉREZ CARREÑO****Atn. Henry Alfonso****S/C N°****FAX: 4728472**

RENG.	COD.	DESCRIPCION	CANT.	PRECIO U.	PRECIO T.
01	6400	Placas Peti film p/Recuento Aerobico Caja X 100Unds.	2,00	181.700,00	363.400,00
02	6407	Placas Peti film p/Hongos y Levaduras Caja X 100Unds.	2,00	241.500,00	483.000,00
03	6410	Placas Peti film p/Recuento E-Coli Caja X 50 Unds.	3,00	195.500,00	586.500,00
04	6420	Placas Peti film p/Enterobacterias Caja X 50Unds.	3,00	124.200,00	372.600,00
		NOTA: Estos son precios en Bolivares, puestos en su laboratorio, calculados a la paridad cambiaria de Bs.1600 por (1) US\$. Cualquier variación será ajustada en los precios al momento del pago.			
				SUB. TOTAL	1.805.500,00
				IVA 16%	288.880,00
				TOTAL	2.094.380,00

TIEMPO DE ENTREGA: Inmediato
VALIDEZ DE LA OFERTA: 10 Días
CONDICIONES DE PAGO: Contado

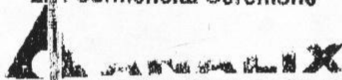
Carmencita Corchione
 L. Carmencita Corchione

 ANALIX INSTRUMENTOS Y APARATOS ANALITICOS

Av. Anaucá Edf. Moisés, Ofc. 6 y 18, San Bernardino, Caracas 1011-A
 Teléfono: 58-212-552.746, Telefax: 58-212-551.1221, P.O. Box: 6635, Caracas 1010- Venezuela
 E-mail: analix@cantv.net

Anexo 55. Presupuesto del Estudio Microbiológico.