

TRABAJO ESPECIAL DE GRADO

**VALIDACION DE UN GENERADOR DE HUMEDAD PORTATIL BASADO EN
INTERCAMBIADORES DE CALOR DE PLACAS PARALELAS RESPECTO A UN
ESTÁNDAR PRIMARIO**

**VALIDATION OF A PORTABLE HUMID GAS GENERATOR BASED ON PLATE
HEAT EXCHANGERS AGAINST A PRIMARY STANDARD GENERATOR**

Presentado ante la Ilustre
Universidad Central de Venezuela
Por el Br. Quintero L. José G.
Para optar al Título de
Ingeniero Mecánico

Caracas, octubre 2015

TRABAJO ESPECIAL DE GRADO

**VALIDACION DE UN GENERADOR DE HUMEDAD PORTATIL BASADO EN
INTERCAMBIADORES DE CALOR DE PLACAS PARALELAS RESPECTO A UN
ESTÁNDAR PRIMARIO**

**VALIDATION OF A PORTABLE HUMID GAS GENERATOR BASED ON PLATE
HEAT EXCHANGERS AGAINST A PRIMARY STANDARD GENERATOR**

Tutor Académico: Dr. Vito Fernicola

Presentado ante la Ilustre
Universidad Central de Venezuela
Por el Br. Quintero L. José G.
Para optar al Título de
Ingeniero Mecánico

Caracas, octubre 2015

VALIDACIÓN DE UN GENERADOR DE GAS HUMEDO PORTATIL BASADO EN INTERCAMBIADORES DE CALOR DE PLACAS PARALELAS RESPECTO A UN ESTÁNDAR PRIMARIO

José Gregorio Quintero Lehmann

Jgquintero90@hotmail.com

jgquinterol@gmail.com

INTRODUCCIÓN

En el campo de la meteorología, la humedad presente en el aire es uno de los parámetros más influyentes, cuya medición y control tiene gran importancia en procesos industriales especialmente aquellos realizados en ambientes corrosivos o procesos de secado con el objetivo de ahorrar energía. Con el fin de garantizar un buen control de humedad es necesario asegurar precisión y fiabilidad en las mediciones de los sensores; por este motivo son necesarios los estándares de medición que sean capaces de ofrecer estados perfectamente conocidos.

Los generadores de gas húmedo son sistemas complejos con importantes dificultades constructivas que los hacen inapropiados para muchas aplicaciones en especial aquellas que necesitan ser aplicadas “in situ”.

Se plantea el diseño de un nuevo generador de gas húmedo portátil con desempeño similar a los conseguidos en laboratorio. El prototipo utiliza un intercambiador de placas corrugadas funcionando como condensador, resultando en un sistema compacto y portátil.

El prototipo debe ser probado y validado respecto a un estándar ya establecido, se espera que el sistema permita procesos de calibración “in situ”, redundando en evidentes beneficios económicos gracias a la disminución del tiempo de transporte hacia laboratorios especializados en su calibración.

METODOLOGÍA

La validación del prototipo es realizada por comparación respecto a un generador de gas húmedo estándar comercial, modelo 2500 producido por la corporación Thunder Scientifics. Fue necesario utilizar un higrómetro de transferencia de alta precisión modelo Michells Optidew Visions que permite la comparación entre ambos generadores; teniendo como consecuencia que la validación consta de dos procesos:

1. Calibración del higrómetro respecto al generador estándar comercial.
2. Validación de la concordancia entre el estado del flujo generado por el prototipo y el estado de saturación usando el higrómetro calibrado.

Se procede a la calibración del higrómetro respecto al generador de humedad estándar el cual incluye la cámara climática donde se posiciona el higrómetro, los datos de la temperatura de rocío son recogidos y almacenados en una base de datos para su posterior análisis.

La calibración exige realizar mediciones estables para descartar cualquier efecto dinámico-aleatorio a diferentes niveles de temperatura; para lograr esto es necesario obtener mediciones durante relativamente grandes intervalos de tiempo; para posteriormente seleccionar intervalos estables de aproximadamente 10 minutos.

Si seleccionamos uno de dichos intervalos es posible ver el comportamiento de la referencia y los sensores bajo calibración.



Gráfico 1. Intervalo estable de 10 minutos.

El objetivo del proceso de calibración es calcular la corrección a ser aplicada en las mediciones del higrómetro calculado como la diferencia entre la medición y el valor dado por el generador.

$$C_h = T_{gen} - T_x$$

Se obtiene una corrección para cada nivel de humedad (expresada en temperatura de rocío) del higrómetro, es posible graficar dichas correcciones obteniendo la curva de corrección de la calibración.

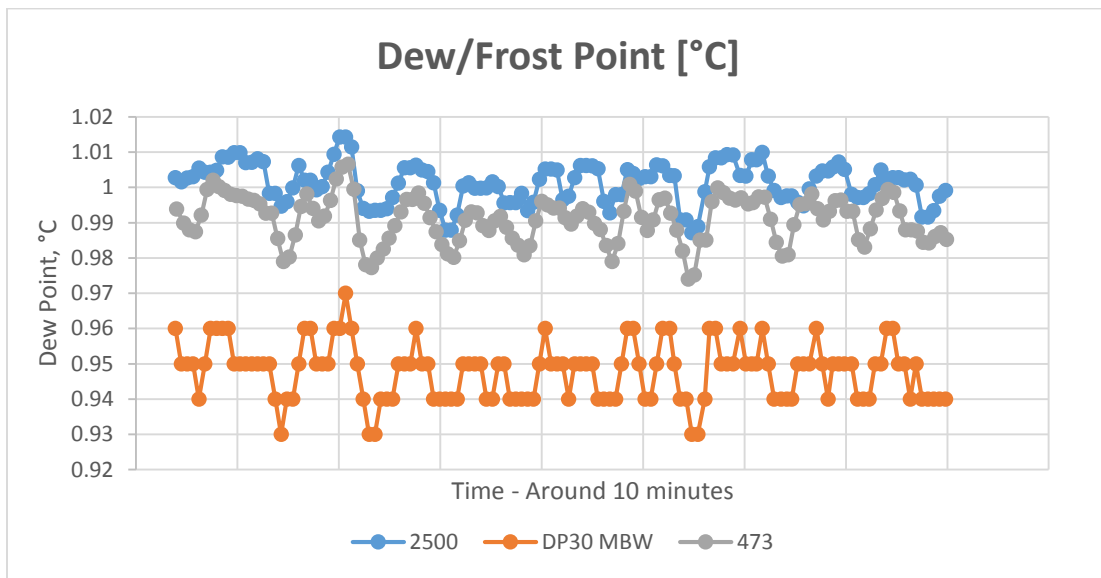

Gráfico 2. Curva de corrección de la calibración

Se hace la observación que un instrumento con buena repetitividad tendrá un comportamiento aproximable con una tendencia suave creciente o decreciente, mientras que un higrómetro cuya repetitividad no sea muy buena la aproximación con una tendencia de este tipo agregara errores considerables; en la figura 2 se puede observar que el higrómetro DP-30 MBW calibrations posee una buena repetitividad, mientras que el higrómetro 473 RH no.

Es igualmente necesario estimar la incertidumbre de la calibración, la cual será la combinación de los siguientes factores a tomar en consideración:

1. Incertidumbre del generador u_{gen} .
2. Desviación estándar del generador u_{std} .
3. Incertidumbre del sensor u_x .
4. Repetitividad del sensor u_{rep} .

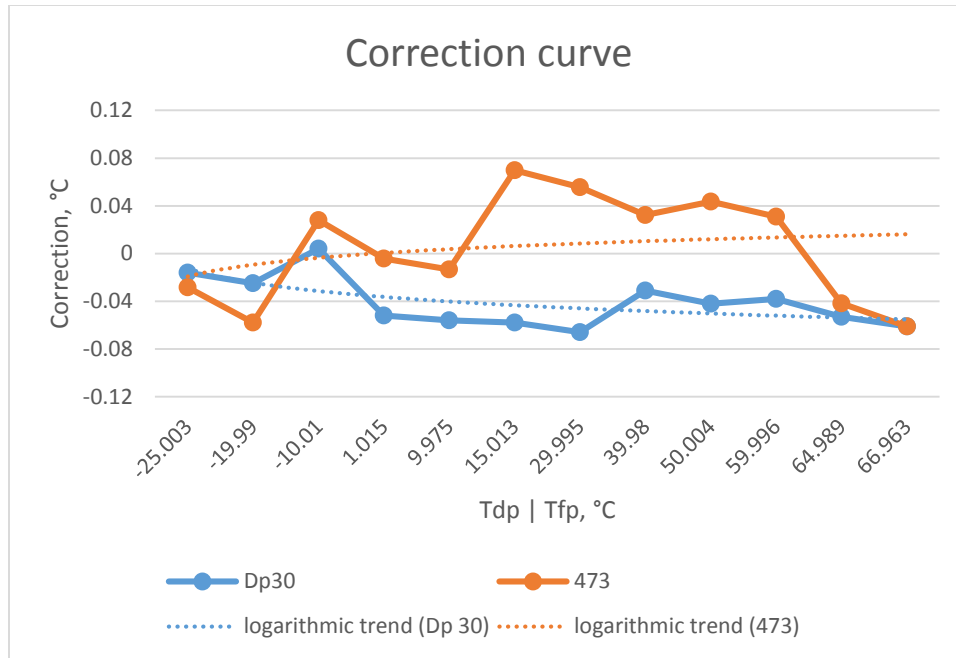
La incertidumbre de calibración será el resultante de la combinación de todas las contribuciones

$$u_{calibracion} = \sqrt{u_{gen}^2 + u_{std}^2 + u_x^2 + u_{rep}^2}.$$

La incertidumbre del generador u_{gen} es perfectamente conocida a partir de la descripción del modelo comercial de thunder scientific, mientras que la incertidumbre del sensor es calculada como la desviación estándar de las mediciones del sensor.

La contribución de la repetitividad del sensor se calcula como la desviación estándar de una distribución probabilística uniforme resultando en:

$$u_{rep} = \frac{|\max(\Delta T) - \min(\Delta T)|}{2 * \sqrt{3}}$$

Luego de tener las curvas de corrección de la calibración y la incertidumbre de calibración relativa a cada nivel de humedad se procede a instalar el higrómetro en el banco de pruebas para la validación del prototipo.



Figura 1. Banco de pruebas de validación del prototipo

El prototipo a ser validado se compone de un pre-saturador que es un recipiente parcialmente lleno de agua alimentado con aire seco (Nitrógeno) donde el aire es burbujeado aumentando su humedad, luego pasa por el lado caliente de un intercambiador de calor donde su temperatura disminuye hasta eventualmente condensar humedad en las superficie de las placas; por el lado frío pasa un flujo de agua alimentado con un baño isotérmico; la temperatura de salida del aire será aproximadamente igual que la temperatura del baño. El aire luego pasa a un dispositivo llamado saturador (que es un recipiente parcialmente lleno de agua) donde alcanza la saturación de forma cuasi estática, para evitar cualquier fenómeno dinámico a la temperatura fijada por el baño isotérmico.

La concordancia entre el estado del aire dentro del saturador y el punto de rocío medido por el higrómetro es la clave en la validación del prototipo, se posiciona un termómetro de platino dentro del saturador, calculando la diferencia:

$$\Delta T = T_{sat} - T_{higrometro}$$

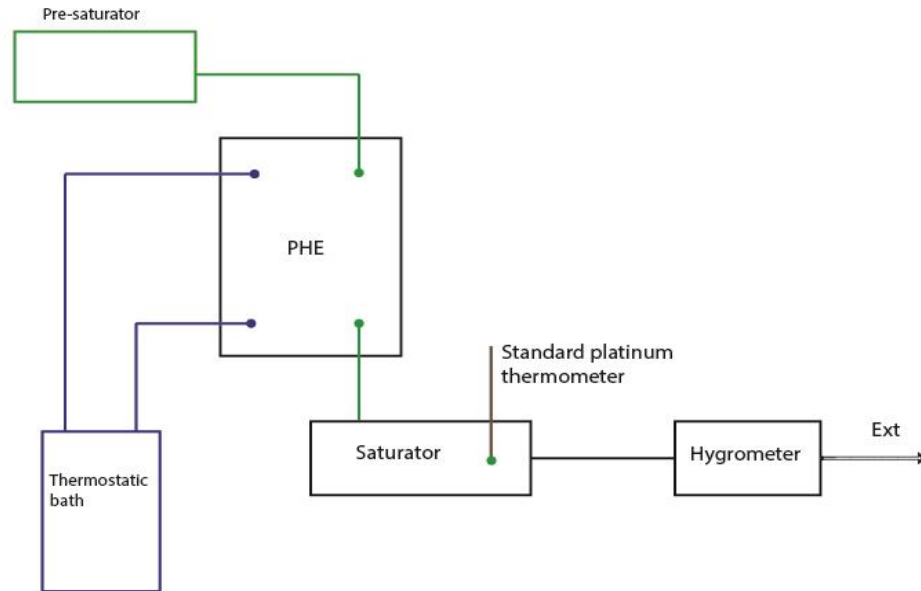

Grafico 3. Prueba de validación realizada a 10°C de punto de rocío

De igual forma será necesario estimar la incertidumbre de la diferencia entre ambas temperaturas combinando las incertidumbres de calibración del higrómetro y del termómetro.

$$u(\Delta T) = \sqrt{u_{calibracion}^2 + u_{termometro}^2}$$

El certificado de calibración del termómetro es dado por el Instituto Nazionale di Ricerca Metrologica con sede en Turin, con una incertidumbre de calibración de 0.15 K en todo el rango de operaciones, como consecuencia la incertidumbre del termómetro será dicha incertidumbre combinado con la desviación estándar de las medidas:

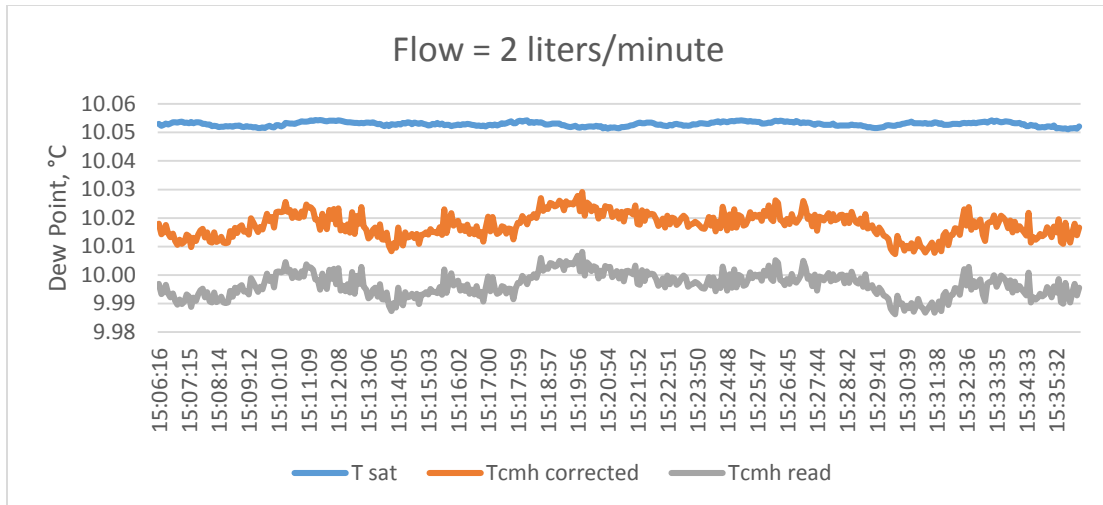
$$u_{termometro} = \sqrt{0.15^2 + u_{std}^2}$$

El funcionamiento del prototipo como estándar primario será validado si la diferencia entre las temperaturas del saturador y punto de rocío son inferior a la incertidumbre expandida de la diferencia.

$$|T_{sat} - T_{higrometro}| \leq 2 * u(\Delta T)$$

RESULTADOS Y DISCUSIÓN

Fueron realizadas varias pruebas a una presión 1.3 bar en un rango de temperaturas de punto de rocío que fueron desde 1 hasta 70 °C, obteniendo como resultado que el prototipo es capaz de funcionar satisfactoriamente como estándar primario con una incertidumbre de $U = 0.12$ °C funcionando desde 1 hasta 60 °C de punto de rocío y mostrando una incertidumbre superior de $U = 0.17$ °C funcionando a los 70°C.



Gráfico 4. Resultados

Fueron realizadas una serie de pruebas preliminares a presiones superiores (3 bar), teniendo como resultado un comportamiento estable de la temperatura de saturación, sin embargo debido al comportamiento inestable del higrómetro fue imposible realizar algún estudio más profundo del comportamiento del prototipo a altas presiones.

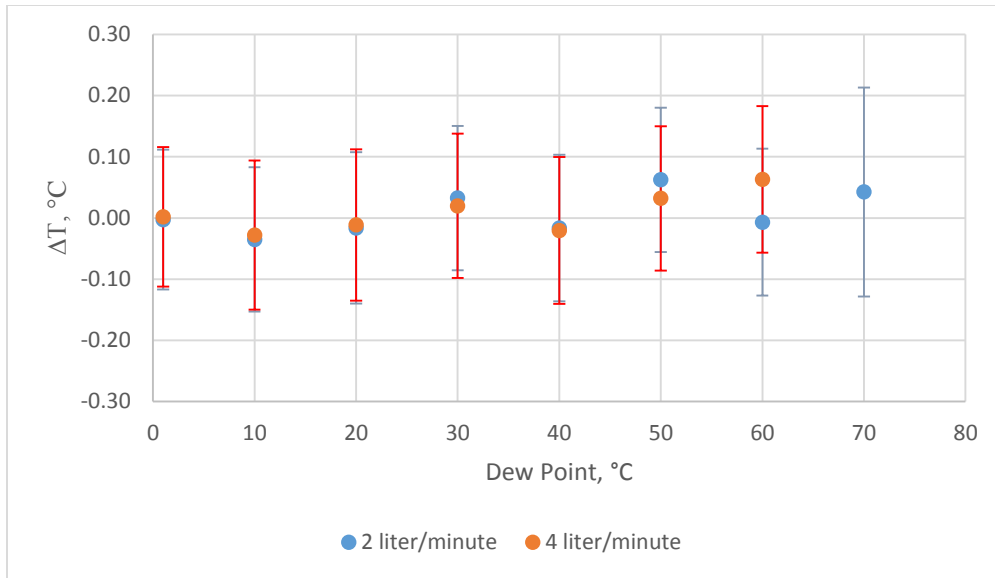

Gráfico 5. Porción de pruebas preliminares a 3 bar

En el gráfico 5 se observa un comportamiento estable de la temperatura de saturación. Los picos de la curva azul representan el proceso de limpieza de la superficie del espejo del higrómetro fijado para ser realizado cada 2 horas; se observa que el higrómetro no es capaz de obtener medidas estables luego de la limpieza.

CONCLUSIONES

Fue validado con éxito un prototipo de generador de humedad portátil trabajando a presión atmosférica respecto a un estándar primario comercial, con una incertidumbre de $u = 0.12\text{ }^{\circ}\text{C}$ trabajando desde 1 a $60\text{ }^{\circ}\text{C}$ de punto de rocío y de $u = 0.17\text{ }^{\circ}\text{C}$ trabajando a $70\text{ }^{\circ}\text{C}$.

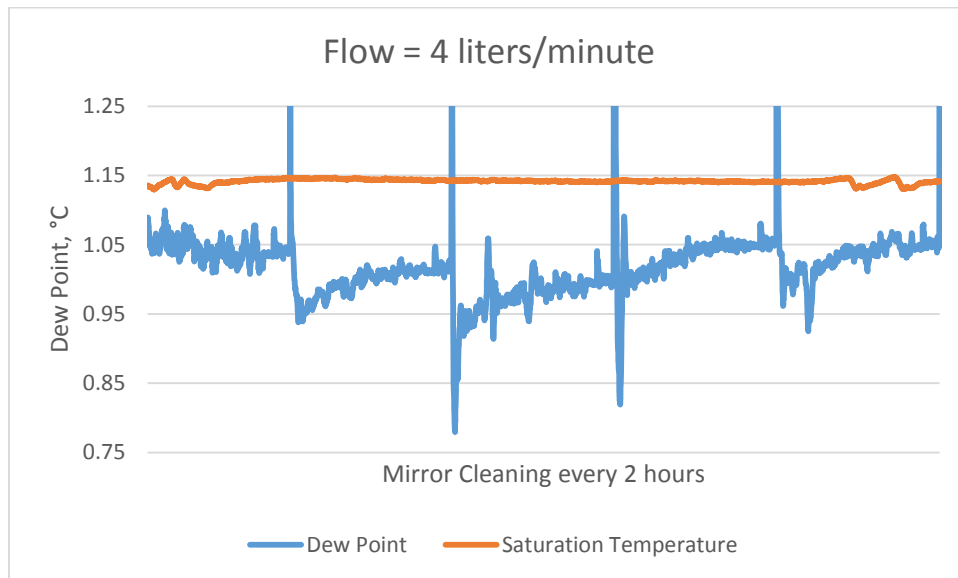
Las pruebas preliminares a presiones superiores (3 bar) muestran un comportamiento estable de la temperatura de saturación de lo cual se puede hacer la hipótesis que el prototipo puede funcionar como generador primario a una presión de 3 bar, sin embargo es necesario un higrómetro que pueda trabajar establemente a dichas presiones para poder comprobar esta suposición, de lo que se concluye que son necesarios estudios futuros para poder validar el prototipo a un rango de presiones más amplio.



**POLYTECHNIC UNIVERSITY OF TURIN
I ENGINEERING SCHOOL**

Laurea Magistrale In Ingegneria Meccanica

Thesis

**VALIDATION OF A PORTABLE HUMID GAS
GENERATOR BASED ON PLATE HEAT EXCHANGERS
AGAINST A PRIMARY STANDARD GENERATOR**

Advisors:

Prof. Dr. Vito Fericola

Denis Smorgon

Candidate:

José Quintero Lehmann

October 2015

ABSTRACT

Nella metrologia, l'umidità presente nell'aria è uno dei parametri più importanti e la sua misura e controllo ha diverse applicazioni nei processi industriali specialmente in ambienti corrosivi o risparmio energetico durante processi di essiccazione. Per avere un buon controllo di umidità è necessario assicurare che le misure dei sensori siano accurate e affidabile; per questo motivo si devono avere dei standard che offrano stati ben definiti per poter tarare gli strumenti.

I generatori di gas umido standard sono sistemi complessi con importanti difficoltà costruttive che gli rendono inadeguati per varie applicazioni specialmente quelle che sono richieste in situ.

Proposto lo sviluppo e costruzione di un nuovo generatore portatile di gas umido con prestazioni simili ai laboratori, il sistema prototipo utilizza uno scambiatore di calore a piastre (Plate Heat Exchanger, PHE in inglese); questa tipologia di scambiatori di calore sono costruite da un set di piastre corrugate di acciaio inossidabile saldate o vincolate tra di loro in parallelo.

Il prototipo deve essere testato e validato rispetto uno standard già impostato, il sistema è previsto di poter permettere di fare tarature in situ, diminuendo il tempo richiesto per trasportare i sensori ad un laboratorio specializzato, avendo evidenti benefici.

ABSTRACT

In the metrology field, the humidity present in air is one of the most influent parameters and which measurement and control has large importance in industrial process, especially those with harsh ambient, energy saving during drying process or optimization. In order to have a good humidity control it is mandatory to ensure accuracy and reliability of humidity sensors; for this reason it is necessary a standard that can offer well-known states for calibration purposes.

Standard humid gas generators are complex systems with large constructive difficulties rendering unsuitable to many applications in special those who require “in situ” calibrations.

It is presented the design of a new portable humid gas generator with similar performance to laboratories, the prototype uses a corrugated plate heat exchanger working as condenser resulting in a compact and portable system. A PHE is formed by a group of stainless steel plates welded or bonded in parallel.

The prototype must be proved and validated against an established standard, it is expected that the system allows to perform “in situ” calibrations, decreasing the required time to transport the sensors to a laboratory having evident benefits.

ACKNOWLEDGEMENTS

The success of this project would not be possible without God, who guided and helped me in every moment, I also dedicate this work to my parents who gave me everything physical and spiritually possible.

I have to thank from all my heart my home the Central University of Venezuela for making possible all the opportunities for my personal growth. I warmly thank the nation and the Italian people for giving me the basic education and welcomed me with their arms open in this country.

I am very grateful with my friends who accompanied me with the double degree program specially my fiancée Helyann Alvarez who also helped for the achievement of this work.

This project was carried out under the tutelage of the Istituto Nazionale di Ricerca Metrologica. I would like to give my deepest gratitude to my relator Dr. Vito Fericola whose dedication and teaching had great importance. I would also like to thank Denis Smorgon, Giulio Beltramino and Shahin Tabandeh for their help which was invaluable throughout the realization of the work.

Table of Contents

CHAPTER 1 - BASIC CONCEPTS	7
1.1.-Thermal Measurement	7
<i>1.1.1.-Thermal Expansion sensors</i>	7
<i>1.1.2.-Thermoelectric sensors</i>	9
<i>1.2.2.-Typical transforms of humid air</i>	14
1.3.-Diffusion	18
1.4.-Hygrometry	19
<i>1.4.1.-Generalities</i>	19
<i>1.4.2.-Summary</i>	27
CHAPTER 2 - CALIBRATIONS	28
2.1.-Generalities	28
2.2.-Humidity sensor's calibration	28
2.3.-Example	30
CHAPTER 3 - INDUSTRIAL APPLICATIONS OF HUMIDITY CONTROL	38
3.1.-Food Industry	38
3.2.-Pharmaceutical industry	41
3.3.-Automotive Industry	42
3.4.-Agriculture	42
3.5.-Air Conditioning	44
3.6.-Nuclear Plants	44
3.7.-Museums	45
CHAPTER 4 - HUMIDITY STANDARDS	46
4.1.-Generalities and components	46
<i>4.1.1.-Pre-Saturator</i>	46
<i>4.1.2.-Saturator</i>	47
<i>4.1.3.-Flow Controller</i>	48
4.2.-Humidity Generators Typologies	48

4.2.1.-Two temperature humidity generators	48
4.2.2.-Two Pressure humidity generators	50
4.2.3.-Divided Flow humidity Generator	51
CHAPTER 5 - DEVELOPMENT OF PORTABLE HUMIDITY GENERATOR AT HIGH TEMPERARURE AND HUMIDITY	54
5.1.-Development of portable humidity generator at high temperature and humidity .	54
5.2.-PHE Description	55
5.3.-Preliminary testing	58
5.3.1.-Pressure drop along the PHE test	58
5.3.2.-Saturation tests	60
5.3.3.-Pressure drop along hygrometer's air line	62
5.4.-Validation of the Humid Gas Generator Prototype	64
5.4.1.-Generalities	64
5.4.2.-Estimation of combined uncertainty	65
5.5.-Validation tests	68
5.6.-Testing at Higher pressure	72
CHAPTER 6 – CONCLUSIONS	75
Appendix A	76
–22°C Dew point measured with DP-30	81
APPENDIX B	82
REFERENCES	84

CHAPTER 1 - BASIC CONCEPTS

First of entering in details of humidity measurements we should first quickly review physics and thermodynamics concepts.

1.1.-Thermal Measurement

Temperature is probably the most important and fundamental parameter present in the meteorological field and has been an interest subject from centuries with countless different techniques be measured. There are very simple techniques with errors from 2° or 3° to very accurate systems with very small errors – less than 0.2°C -.

Temperature can be measured using several different units – Rankine, Reaumur, Celsius, Fahrenheit, Kelvin-, but nowadays Kelvin and Celsius – K and $^\circ\text{C}$ - are preferred. Those two scales are similar each other's, being Kelvin an absolute scale.

$$K = ^\circ\text{C} + 273.15$$

The zero Kelvin is commonly known as absolute zero and no temperature can be below.

$$K \geq 0 \wedge ^\circ\text{C} \geq -273.15$$

In the field of humidity measurement is quite often and important an accurate temperature's measurement, for this reason we will review some principal measurements methods.

There are many types of temperature sensors and can be grouped according to their physical principle like thermal expansion, thermoelectric, electrical resistance, electrical capacitance and others.

1.1.1.-Thermal Expansion sensors

Thermal expansion is the tendency of matter to change in volume in response to a change in temperature [4].

Temperature is a monotonic function of the average molecular kinetic energy of a substance, when this substance is heated their kinetic energy of their molecules increases too therefore their molecules which increases their movement begins to have a greater average separation between them. There are substances that decrease their molecular separations with increasing the temperature, but are a very unusual and

limited effect; water as example, expands when temperature decreases from 4°C and in solid state has greater specific volume –volume per mass unit- than liquid water [5]; this water phenomenon is caused by hydrogen bonds.

Independent from the substance behavior, there will be a relationship between specific volume and temperature.

$$v = v(T)$$

We can then, theoretically, know a temperature by measuring a substance's dimensions. If we pick a unidimensional solid there will be a relationship between his length and the ambient temperature –in case of thermodynamic equilibrium-.

$$L = L(T)$$

Is almost useless to measure in absolute length of a longitudinal material, is more practical to measure the size's variation.

$$\Delta L = \alpha L_0 \Delta T$$

The parameter α is defined as linear expansion coefficient, is the length's variation in temperature function of a determinate material. This coefficient is assumed as a material property, but may be affected by other meteorological parameters; materials with linear relationship between ΔT and ΔL are ideal – α constant in temperature range-.

Some thermometers that follow this operation principle are:

- Bimetallic Strips: is a pair of metals with different thermal expansion coefficient – α -, bonded together, at a reference temperature the pair has the original shape usually linear rod or strip. When a different temperature from the reference, the material exists will bend or a deflection will be noticed, we can measure the temperature in deflection function.
- Liquid in glass: is a glass cylinder filled with any liquid, the glass has strips that indicates the temperature in which the liquid level will reach to that level. Those thermometers are very popular, especially old mercury thermometers with medical applications. Actually thermometers with alcohol are preferred.

1.1.2.-Thermoelectric sensors

1.1.2.1.-Thermocouples

When two dissimilar metals are in contact in a junction and form a closed circuit –two different junctions-, if the junctions are at different temperatures, there will be a voltage between those two junctions. If one junction's temperature is well known, the other junction's temperature can be known by measuring the voltage; thermocouples work thanks to the Seebeck effect as physical principle, this effect creates an electromotive force wherever there is a temperature gradient.

Thermocouples provide a fast response, good accuracy and are inexpensive but they have very low output voltages $\sim 40 \mu\text{V}/^\circ\text{C}$, hence amplifiers are needed, to make the output readable.

Other thermocouples' inconvenience is the requirement to know the reference junction's temperature; there are two main strategies to solve this:

- The reference junction is immersed in a semi-frozen bath of distilled water at atmospheric pressure. Knowing that in a biphasic water state the temperature will be 0°C .
- To use a secondary thermometer that compensates the voltage; this has the advantage of using one pair to an extreme temperature while the "cold junction" is at other non-extreme temperature that allows a cheaper device.

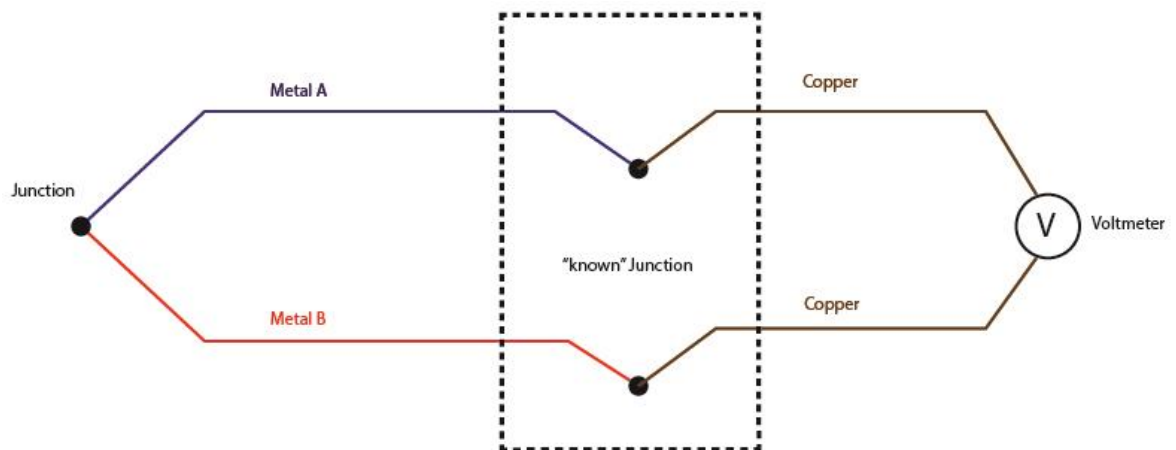

Figure 1 – Thermocouple operational scheme

1.1.2.2.-Electrical Resistance Sensors

As the specific volume, the thermal resistance is affected by temperature variations, there are materials that changes their resistance in temperature function. We can discuss the following are two groups:

- Resistance Temperature Detectors (RTD):

Are typically used in precision measurements, platinum is the most commonly used material because is chemically stable, resist corrosion, has high melting point, easily workable and can be obtained with high degree of purity rendering the relationship between temperature and resistance highly lineal but is sensitive to strain and bending. Those platinum resistance thermometers are commonly known as PRT.

The resistance of a PRT is given by:

$$R_T = R_0(1 + \alpha T + \beta T^2)$$

Where:

R_0 : is the resistance at 0 °C.

R_T : is the sensor's resistance at temperature T in °C.

The coefficient values are dependent on the purity of the platinum, typically:

$$0.00385 \leq \alpha \leq 0.0039 \text{ [}^\circ\text{C}^{-1}\text{]}$$

$$\beta = -5.85 \times 10^{-7} \text{ }^\circ\text{C}^{-2}$$

In some cases PRT's resistance includes a fourth parameter γ that is only used in very low temperatures and values zero at temperatures over 0°C.

$$R_T = R_0(1 + \alpha T + \beta T^2 + \gamma(1 - 100)T^3)$$

The quadratic parameter γ is usually neglected due to its small order of magnitude, around of $\times 10^{-12}$.

- Thermistors

Are devices with resistance sensitive to temperature, typically made by metallic oxides, they are small, cheap and are characterized by large non-linear behavior.

$$R = R_0 e^{\beta(1/T - 1/T_0)}$$

Those devices tend to suffer aging due to their oxide nature, if the oxidation continues the material will change their properties. They are suitable only in some commercial and industrial applications but for laboratories purposes the PRT are preferred.

The following figure show a bridge used to measure the resistance value related to the temperature value

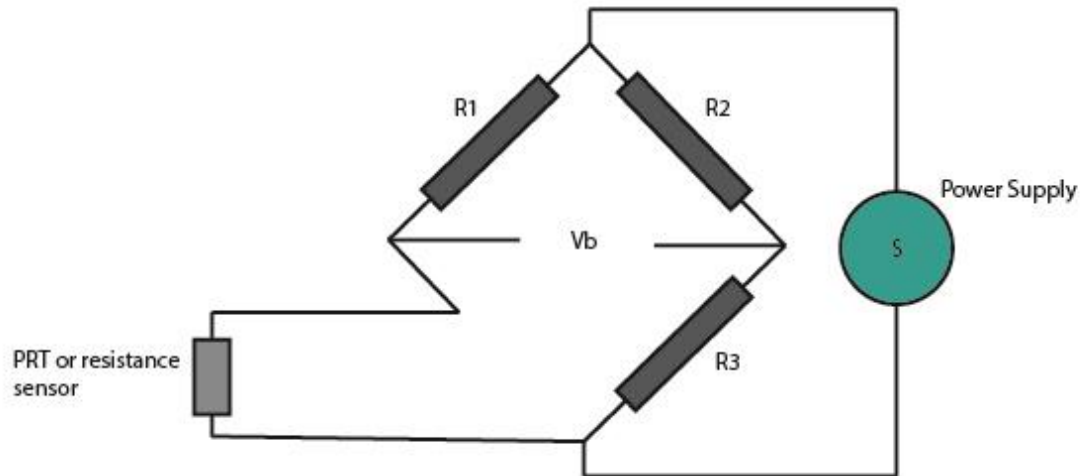

Figure 2 – Wheastone bridge used to measure resistance's variation

1.2-Psychrometrics

1.2.1- Generalities

Psychrometrics is the field of engineering concerned with the determination of physical and thermodynamics properties of gas-vapor mixtures [1]. When a gas is treated as ideal gas is considerate that the following state equation can predict its behavior:

$$PV = nRT$$

Where:

P : Is the absolute pressure.

V : Is the volume which that gas occupies.

n : Number of gas' moles.

R : Gas' universal constant.

T : Absolute temperature

The ideal gas law is valid when there are low interaction between the molecules, this happens in thermodynamic states far from condensation either at low pressures or high temperatures. It is well known that at ambient conditions the water state is close to condensation, but water vapor in air has very low partial pressures, this renders the water vapor behavior similar to ideal gas.

We define the dew point temperature as the point where air reaches the saturation along a chilling process at constant absolute water content, at this temperature water droplets are formed over the slightly cooler surfaces where air flows.

Can be also defined the wet bulb temperature t_b as the water temperature with heat and mass transfer equilibrium and the dry bulb temperature t_d as the air temperature. The humid bulb temperature can be approximated to the dew point temperature.

Using these temperatures it is possible to build a simple measurement device that permits to know the relative humidity values, knowing that when t_d and t_b temperatures are equal the relative humidity is $RH = 100\%$.

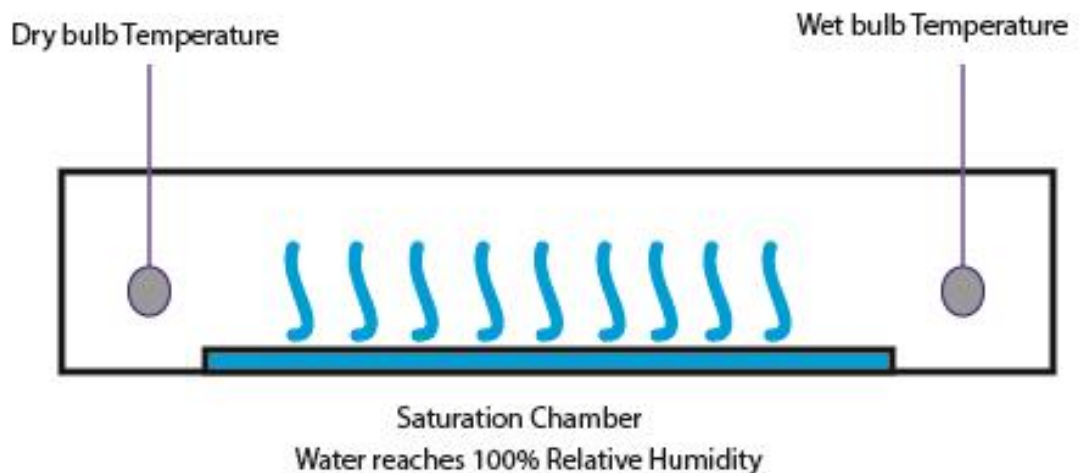

Figure 3 – Psychrometer operational scheme

This instrument is known as psychrometer, is composed by two thermometers, one of them has the bulb wetted giving the t_b temperature while the other thermometer offers the t_d temperature. An air flow is forced through the instrument in order to ensure optimal operation. Only in the case of high relative humidity values –low difference between t_d and t_b - or strong ambient wind, the forced ventilation will be unwanted.

It is important to note that the humid bulb temperature has slightly dependence on atmospheric pressure and wind velocity.



Figure 4 – Typical Psychrometer

In psychrometrics, humid air is a composition of two different gasses:

1. Water vapor: is the condensing component, is treated as a perfect gas due to the low partial pressure.
2. Dry gas: treated as pure substance even if is a mixture of other ideal gasses – Nitrogen 75%, Oxygen 23%, Argon and others-.

We define absolute humidity as the water content in dry air –neglecting the water mass-

$$x = \frac{M_v}{M_a} = \frac{\rho_v}{\rho_a}$$

We can rewrite x as:

$$x = \frac{\rho_v}{\rho_a} = \frac{P_v/R_v T}{P_a/R_a T} = \frac{R_a P_v}{R_v P_a}$$

Applying the *Dalton's law* $p = p_a + p_v$

$$R_v = 461 \frac{J}{kg K}, R_a = 287 \frac{J}{kg K}$$

$$x = 0.622 \frac{p_v}{p_a} = 0.622 \frac{p_v}{p - p_v}$$

We proceed to define the relative humidity ϕ as the relationship between the water vapor content in humid air and the maximum water that can be allowed –in mass- in the same dry air volume with equal temperature and pressure conditions. When air cannot contain more water vapor is known “saturated air”.

$$\phi = \frac{M_v}{M_s} = \frac{\rho_v}{\rho_s}$$

If the temperature remains constant:

$$p_v v_v = R * T = p_s v_s$$

$$\phi = p_v/p_s$$

This value –relative humidity or RH- is express in percentage, commonly known as %RH. Can the absolute humidity x be determined knowing the relative humidity %RH?

It is necessary to know the atmospheric pressure, in the case of sea level we can replace ϕp_s and p_v in $x = 0.622 \frac{p_v}{p - p_v}$ having:

$$x = 0.622 \frac{\phi p_s}{p - \phi p_s}$$

Using this expression is possible to know p_s and x using water vapor charts and relative humidity readings coming from hygrometers.

1.2.2.-Typical transforms of humid air

Main humid air transformations present in psychrometrics will be discuss in the following part including their respective Carrier and Mollier diagrams.

1. Adiabatic mixing: is a mixing between air flows with different thermodynamic states and fluxes. Imagine we have two air flows \dot{m}_1 and \dot{m}_2 :



Figure 5 – Schematic mixing process

$$\begin{aligned} \dot{m}_3 &= \dot{m}_2 + \dot{m}_1 \text{ (mass balance) } \{1\} \\ \dot{m}_3 * x_3 &= \dot{m}_2 * x_2 + \dot{m}_1 * x_1 \text{ (water mass balance) } \{2\} \\ \dot{m}_3 * h_3 &= \dot{m}_1 * h_1 + \dot{m}_2 * h_2 \text{ (energy balance) } \{3\} \end{aligned}$$

Putting the {1} in the {2} and {3} equations:

$$\dot{m}_1(h_3 - h_1) = \dot{m}_2(h_2 - h_3)$$

$$\dot{m}_1(x_3 - x_1) = \dot{m}_2(x_2 - x_3)$$

Relationship between flows will be:

$$\frac{\dot{m}_1}{\dot{m}_2} = \frac{h_2 - h_3}{h_3 - h_1} = \frac{x_2 - x_3}{x_3 - x_1}$$

2. Heating and chilling with constant absolute humidity: is a process where air can absorb or release heat varying its relative humidity.

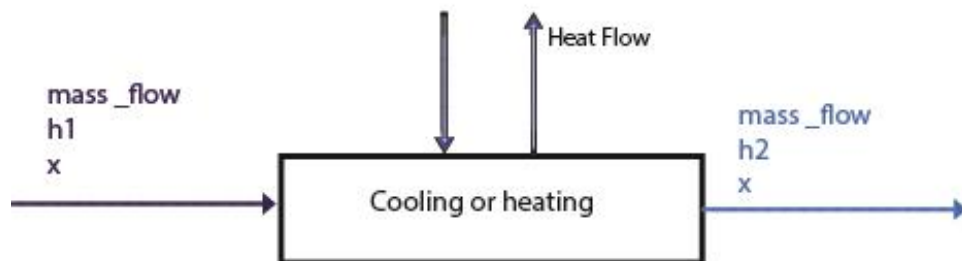

Figure 6 – Schematic cooling/heating process

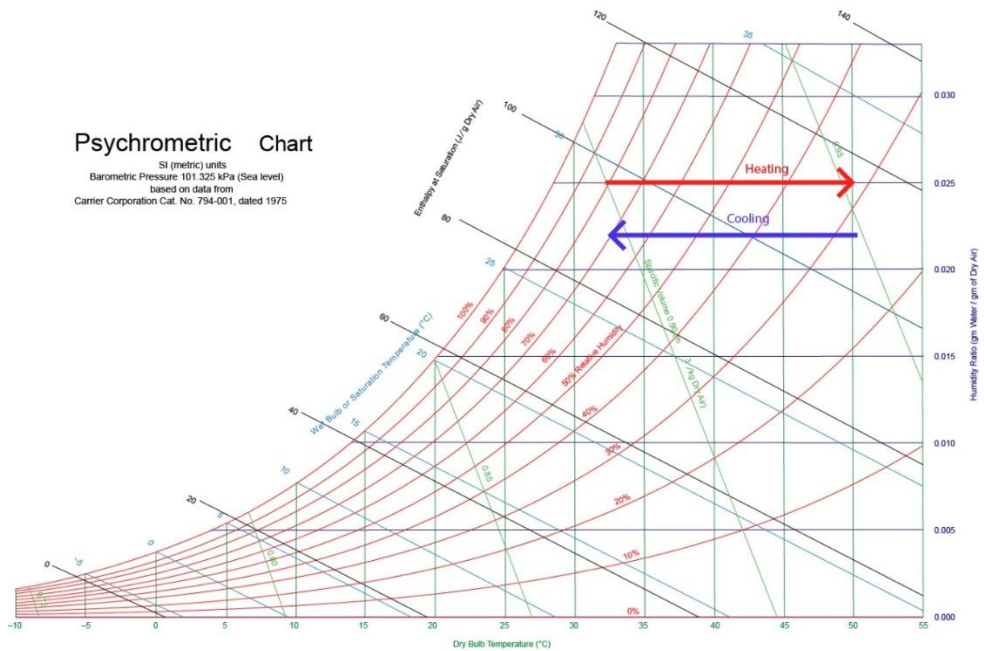

Figure 7 – Carrier diagram of heating or cooling process

3. Cooling with dehumidification: occurs when an air flow passes through a chilling component which absorbs heat increasing its relative humidity without varying the absolute water content until reach the saturation, at this point liquid state water starts to condensate along the iso-humidity line of $RH = 100\%$.

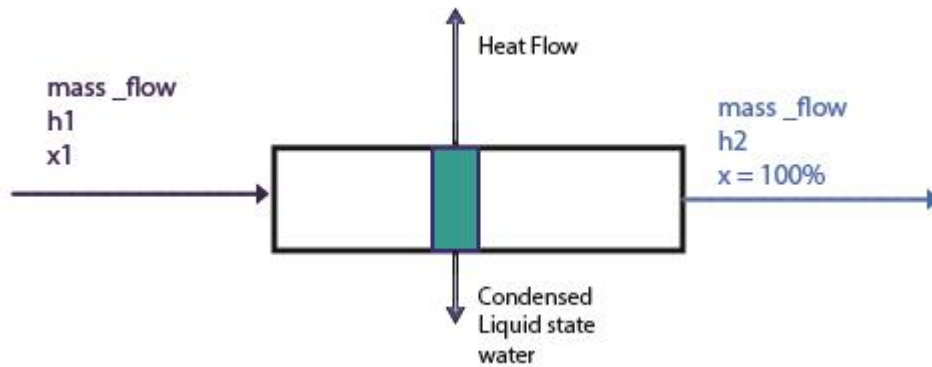

Figure 8 – Schematic cooling with dehumidification process

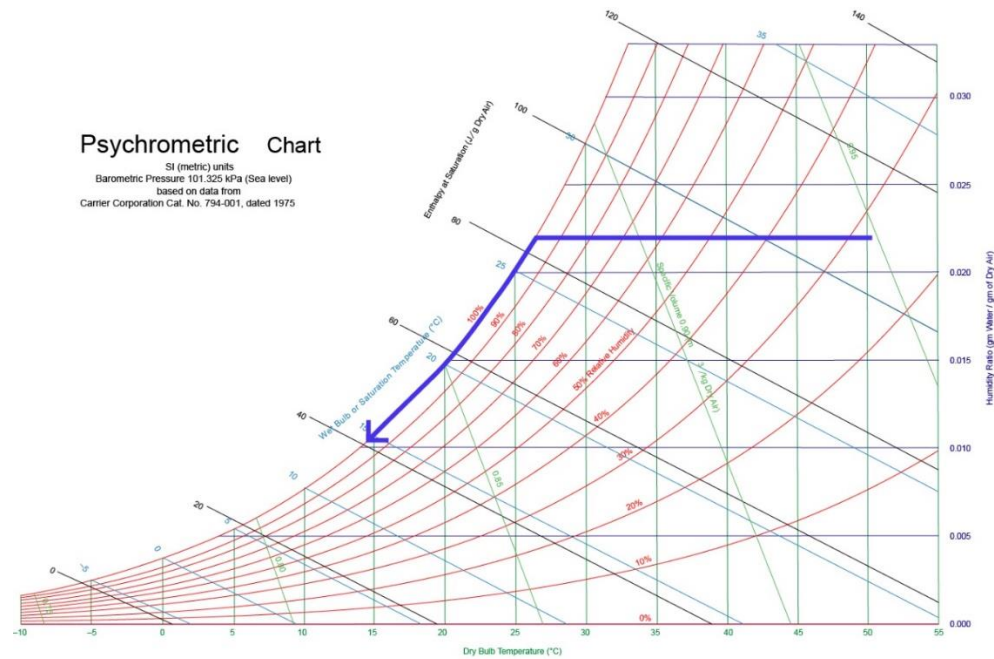

Figure 9 – Carrier diagram of cooling with dehumidification process

4. Adiabatic humidification: when air flows through an element that adds water vapor and making the assumption of no heat transfer we have:

$$\dot{m}(x_2 - x_1) = \dot{m}_{H_2O}$$



Figure 10 – Schematic adiabatic humidification process

Applying the second principle of thermodynamics:

$$-\dot{m} * h_1 + \dot{m} * h_2 - \dot{m} * h_{H_2O} = 0$$

Enthalpy can be express as: $h_{H_2O} = Cp_{H_2O} * T_{H_2O}$

$$\dot{m}(h_2 - h_1) = \dot{m}_{H_2O} * C_{p_{H_2O}} * T_{H_2O}$$

Dividing both sides by \dot{m}

$$h_2 - h_1 = \frac{\dot{m}}{\dot{m}}(x_2 - x_1) * C_{p_{H_2O}} * T_{H_2O} = (x_2 - x_1) * C_{p_{H_2O}} * T_{H_2O}$$

The term $(x_2 - x_1) * C_{p_{H_2O}} * T_{H_2O}$ is small, hence adiabatic humidification can be considered as iso-enthalpy process $h_2 \approx h_1$, and during the process air can reach the saturation being this point approachable with wet bulb temperature.

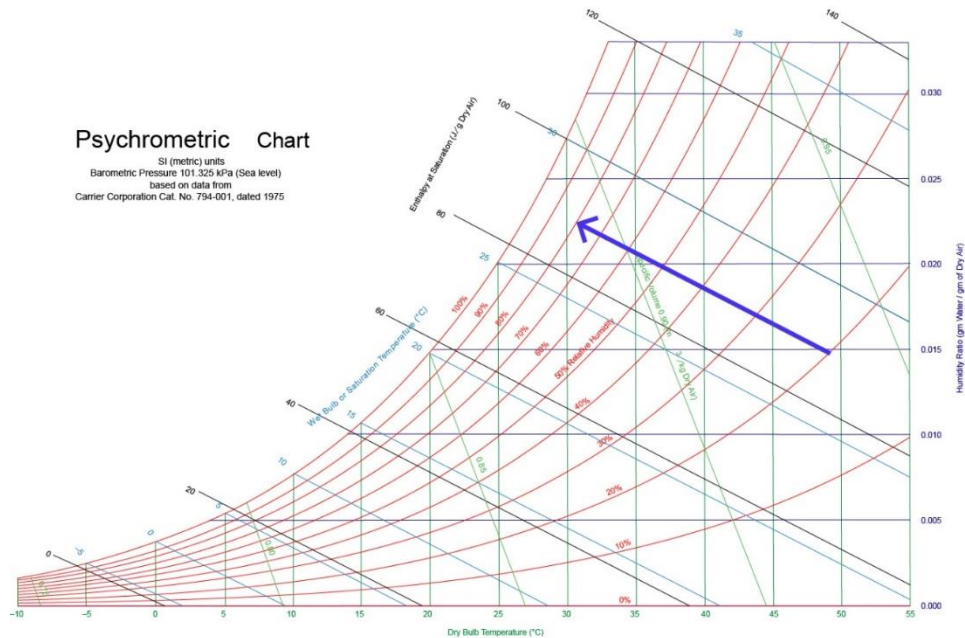

Figure 11 – Carrier diagram of adiabatic humidification process

1.3.-Diffusion

Diffusion is the net movement of a substance from a region of high concentration to a region of low concentration to a region of low concentration. This is also referred to as the movement of a substance down a concentration gradient [1]. The diffusion is described by the *Fick's law* which relates the diffusive flow to the concentration under the assumption of steady state.

The law postulates that the flow goes from regions with high concentration to low concentration regions with a magnitude proportional to the concentration gradient. We can simply say that a solute will move from a high concentration region to a low concentration across a concentration gradient.

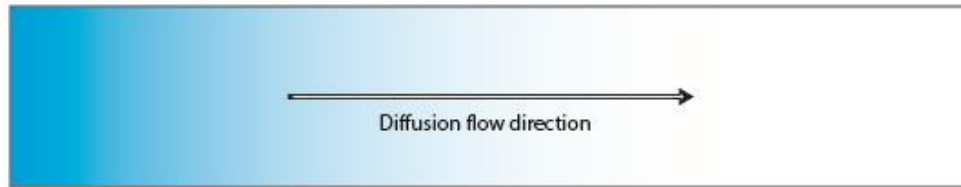

Figure 12 – Diffusion schema

The *Fick's law* expressed in one dimension is:

$$J = -D \frac{\partial \phi}{\partial x}$$

Where

- J Is the amount of substance per unit area per time.
- D Is the diffusion coefficient or diffusivity.
- ϕ Is the concentration.

Many models have been developed on basis of the *Fick's law*, those models describes the transport processes in foods, neurons, biopolymers, pharmaceuticals, porous soils, population dynamics, nuclear materials, semiconductor doping process and others.

1.4.-Hygrometry

1.4.1.-Generalities

The scope of hygrometry is to determine how much water vapor is present in the ambient using weight, volume, partial pressures (percentage), fractions or saturation (equilibrium) respect a plane surface of distilled water. From all the meteorological measurements, humidity is the most troublesome, especially when costs have elevated specific weight.

According to Arnold Wexler humidity measuring methods can be classified in six groups based on physical principles.

1.4.1.1.-Removal of Water Vapor from Moist Air

This typology bases its function on the separation or removal of water vapor from the moist air. There are various separation methods, and is the main principle of standard laboratory techniques, the amount of water sample –removed from air moisture– determines the humidity in the moist, gravimetric hygrometers bases its function on this typology.

This is the most accurate method, but can be cumbersome especially when low humidity, typically from low dew point temperatures values –lower than $-20\text{ }^{\circ}\text{C}$ -. In low humidity ranges, water content in air tends to be small and it takes an elevated time –can be hours- to obtain a reasonable sample to make a single measurement.

1.4.1.2.-Addition of Water Vapor to Air

In contrast of the previous method is it possible to determine the humidity by adding water vapor to the air sample until reach the complete saturation $\varphi = 100\%$, the amount of water vapor added to the sample can be measured and perfectly known then is possible to know the humidity present in the “dry” sample, this technique is a laboratory method, but there are some simpler variations.

Psychrometry is a method based on the philosophy of adding water vapor to moist air but without measuring water added to reach the saturation, we described previously that humidity is determined from the difference between the wet and dry bulb temperatures.

1.4.1.3.-Equilibrium Sorption of Water Vapor

Humidity present in ambient interacts with almost every substance –being water highly reactive-, it will be a process of sorption –absorption or adsorption- between a substance and the air, we can find a daily example in food conservation field, food tends to exchange humidity with the surrounding ambient, this process should be minimized to ensure their preservation for longer time.

In measurement field, materials tends to change their physical properties in function of relative humidity of the surrounding ambient, those physical properties could be

density –expand or contract-, variation of electrical or capacitance. Hence we measure the variation of those properties making a correlation between the humidity.

We should add that almost impossible to find a plane surface of pure water in nature, and consequently even more impossible have water vapor in equilibrium with it. According to the definition of relative humidity, we won't ever have relative humidity as input parameter of humidity sensors. RH must be calculated somehow by those inputs parameters. Sorption sensors must also be slightly hygroscopic –capacity of attracting water- and porous to guarantee its function in low relative humidity conditions at high temperatures.

We can sub-classify hygrometers of equilibrium sorption of water vapor in two.

- Mechanical Hygrometers

Nicholas de Cusa 1401-1464 made a curious observation, he noticed that wood changes his weight in function of humidity; he also noticed that hair length is affected by the same parameter. Based on this phenomena there are that basses its function in dimensionally variable materials like silk, hair, cotton, nylon, paper, wood and others. Those hygrometers have the disadvantage of being nonlinear, high hysteresis, tend to suffer drift and aging in time.

- Electric Hygrometers

Electric Hygrometers are sorption sensors that change an electrical parameter – resistance or capacitance- with respect an input that can be vapor pressure and temperature.

The sensors are made by polymers with low dielectric constant -4 dimensionless- that allows water vapor transport. The measure is made taking advantage of the high dielectric constant of the water -80 approximate-, dust can affect this sensor, changing the capacity of absorbing water vapor producing drift. This could be solved by cleaning the sensor.

Another type of sensor is the called bulk polymer, which decreases its electrical resistance with humidity increasing; this resistance variation can be measured using a Wheatstone bridge or 4 wires system.

Electric hygrometers have the advantage of being usually small and inexpensive, are also suitable for remote measurements but require periodical calibration and could have sensitivity to temperature and contamination. They also could have large hysteresis and response time.

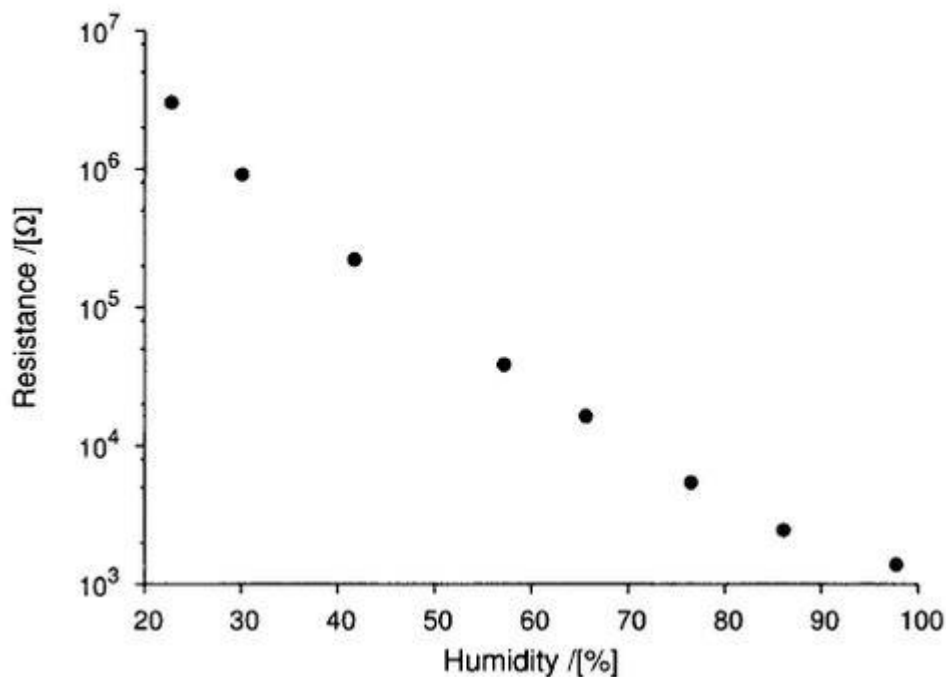

Figure 13 – Typical resistance variation vs humidity of a polymeric sensor

Johannes Karl Fink – Polymeric sensors and actuators page 82

1.4.1.4.-Measurement of Physical Properties of Moist Air

Moist air has measurable physical properties which can be function of the amount of water vapor present in such as refractive index, radiative absorption, thermal conductivity, viscosity, density and sonic velocity.

Water vapor present in air tends to absorb some bands of electromagnetic spectrum, by measuring the attenuation of radiation in that specific band. The lyman-alpha hygrometer bases its function in this principle –using lyman-alpha emissions-.

There are laser hygrometers, they are very expensive and have the issue of presence of other atmospheric gas that can be absorbing radiation is not desiderate, for solving this are used bands from 1000 nm to 3000 nm because –also- there's less solar and earth background radiation, in the wavelength of 2800 nm glass has high transitivity.

The lyman-alpha hygrometer emits radiation equal of atomic hydrogen at 121.56 nm -ultraviolet range-. The protection window must be made by a magnesium fluoride – capable of transmit from 115 nm to 132 nm - because glass is opaque at this wavelength. Water vapor has an absorption peak at 121.56 nm. The read value should be corrected because oxygen and ozone absorbs at 121.56 nm. Has the advantage of

being simpler, smaller and having fast response than IR hygrometer or chilled mirror hygrometer, this type of hygrometer is ideal for aircrafts and metrological tower measurements.

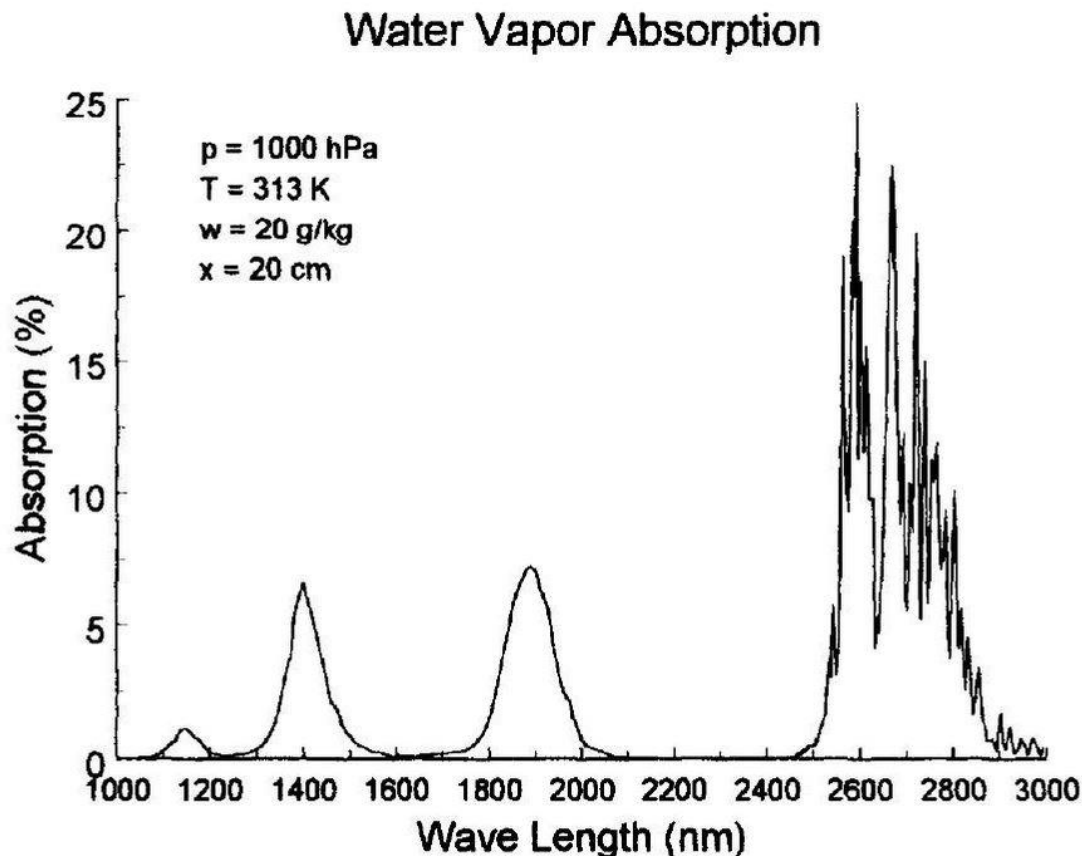

Figure 14 – Water Absorption vs Wave Length

Brock Fred V. Richardson Scott J. – Metrological Measurement Systems page 103

1.4.1.5.-Attainment of Vapor-liquid or Vapor Solid Equilibrium

The equilibrium state between vapor-liquid or vapor solid equilibrium can provide us two major methods to measure humidity in air.

- Dew and Frost point hygrometer

Is possible to determinate dew-frost point by cooling a clean surface until reach the saturation and appears condensation over the surface. These types of hygrometers are known as chilled mirror hygrometers. An air flow is passed through a mirror surface which has a heating-cooling system, also includes a sensor to measure and control system that regulates the temperature of the mirror surface.

The inlet air is filtered to remove dust particles and solid contaminants, these filters and the whole inlet system should be non-hygroscopic because if they absorb water vapor from the inlet generating drifts.

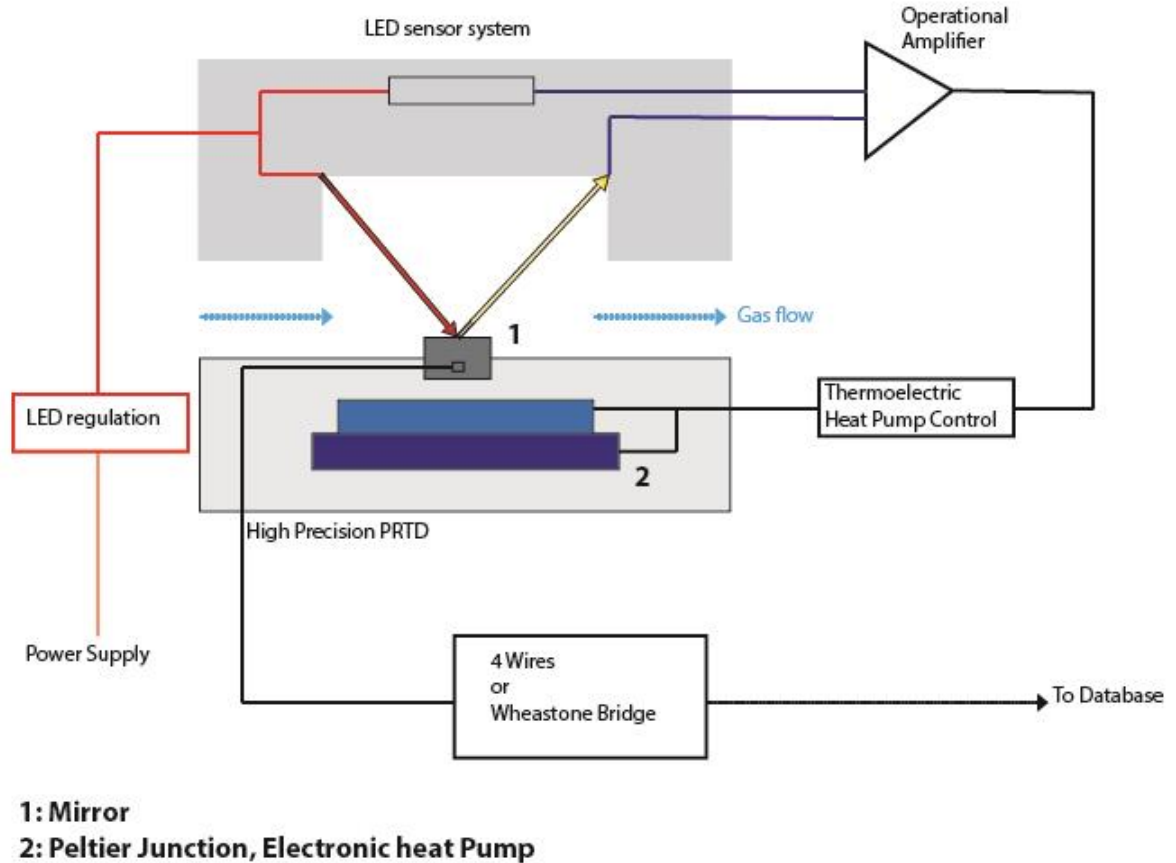

Figure 15 – Chilled Mirror Hygrometer operation scheme

The mirror surface is heated or cooled using a thermocouple heat with Peltier effect, rendering the system compact and reversible. The time response is determined by the speed in which the mirror can be heated or cooled.

Hygrometer is provided with a LED optical sensor and other photo-detectors that senses any change in light scattering when dew or frost appears on the mirror surface in comparison to plain-polished surface. These sensors cannot make difference between frost and dew –at temperatures below freezing-, for this reason the hygrometer also includes a window that allows seeing the mirror, which allows us to know if frost or dew is formed on the surface.

Dew point method requires periodical calibration because is influenced by several factors:

- a. As we commented previously, at low temperatures on the mirror's surface dew or frost can be formed, this can generate error.
- b. The presence of contaminants like salts can lower the vapor pressure giving a lower dew point. For this reason chilled mirror hygrometers must be cleaned periodically.
- c. Over the surface of the mirror will form condensate, if this condensate generates very small droplets, the vapor pressure will increase giving a higher dew point.
- d. We can only measure the mirror's surface temperature, not the droplet or frost surface temperature; there may be a temperature gradient between those two surfaces.
- e. The inner control system must be able to sense high rates of change of air's humidity because this control system can fail flooding the mirror giving huge errors.

Chilled mirror hygrometers includes systems that regulates their operation minimizing the time in which dew is formed on the surface and hence keeping the mirror cleaned a longer time. The system chills the mirror until reach the formation of dew records the temperature, then heats slightly and chills again for doing another measure.

Other operation usually made to increase the period in which the mirror must be cleaned is to chill the mirror and then heat for a short time; the objective is to accumulate the contamination in certain points instead of having it distributed along the mirror –case in which the error would be greater-.

- Saturated salt solutions

The relative humidity in air over a salt solution will be lower than over distilled water, this phenomenon is caused by the absorption of water by both liquid and gas phases and the volatile salt molecules are only present in the liquid phase, the system stabilizes at a relative humidity lower than 100%.

This phenomenon is present in all salt solutions, saturated or not, using saturated solutions renders –theoretically- constant the relative humidity in moist air, even if water enters or leaves the solution from the air, the relative humidity will depend on the salt used to saturate the solution.

This method has some problems related to the salt nature; they tend to crystallize along the container's surface. Other unwanted phenomenon is the presence of a relative humidity gradient normal to the solution's surface.

Using a kit of various salts is possible to make controlled RH ambient which can be used to make calibrations to humidity sensors.

<i>Salt</i>	<i>Humidity [%RH]</i>
<i>LiCl</i>	11
<i>CaCl x 6H₂O</i>	31
<i>MgCl₂</i>	33
<i>Ca(NO₃)₂ x 4H₂O</i>	51
<i>NaBr</i>	57
<i>NaCl</i>	75
<i>NH₄Cl</i>	79
<i>KBr</i>	85
<i>K₂SO₄</i>	97
<i>CuSO₄ x 5H₂O</i>	98

Table 1 – Equilibrium humidity of diverse salts – Polymeric sensors and actuators, Johannes Karl Fink table 1.1

1.4.1.6.-Chemical Reactions

Using methods based on chemical reactions it is possible to determinate the water content present in a sample even if it is not air. However, titration methods like Karl Fischer are suitable to hygrometry.

Is a chemical analysis process based on the oxidation of sulfur dioxide with iodine in a methyl hydroxide solution having the following reaction –being **RN** a generic base molecule-.



The titration can be made in volumetric or coulometric form:

1. In the volumetric titration a Karl Fischer solution that contains iodine is added until notice the first traces of unreacted iodine. The amount of iodine converted is determined by volume inside Karl-Fischer's burette with iodine content.
2. In the Coulometric method, reacting iodine is generated directly by the titration cell by electrochemical oxidation of iodide until notice the first traces of unreacted iodine. Following the *Faraday law* can be applied to determinate the amount of reacting iodine from the electrical power consumed.

Karl Fischer method is suitable to determinate the amount of water content in high variety of samples, from those who have high amount of moisture to those samples with water content in ppm.

Chemical reaction methods are complex and are hard to apply to fluxes, but due to their high precision are suitable to laboratory applications.

1.4.2-Summary

The following table exposes the main characteristics of instruments and methods used for hygrometry.

Physical Principle	Method	Costs	Ranks	Precision	Main Applications
1	Gravimetric	Very High	-50 to +50	Very high	Laboratory
2	Psychrometrics	Low	5 to 95 %RH	Medium	Industrial
3	Mechanical (hair)	Medium	15 – 95 %	Medium	Industrial-Metrology
3	Electrical Resistive	Low	5-90%	Media-Baja	Industrial
3	Electrical Capacitive	Low	2-95%	Media-Baja	Industrial
4	Lyman-Alfa	Very High	Ppm – 99%	Very High	Military-Metrology-Industrial
5	Chilled Mirror	Very High	-80 to +40	Very High	Industrial-Laboratory
5	Salty solutions	Medium-Low	11 to 90	Very low	Industrial-Metrology
6	Karl-Fischer	High	Ppb to ---	Very High	Laboratory

Table 2 – Comparisson between humidity sensors

CHAPTER 2 - CALIBRATIONS

2.1.-Generalities

Is the process of comparison between measurements obtained by one instrument provides the reference pattern which is well known and another measurement made by a second device under calibration. The reference device is called the standard.

The formal definition is given by the International Bureau of Weights and Measures is the following: "Operation that, under specified conditions, in a first step, establishes a relation between the quantity values with measurement uncertainties provided by measurement standards and corresponding indications with associated measurement uncertainties (of the calibrated instrument or secondary standard) and, in a second step, uses this information to establish a relation for obtaining a measurement result from an indication."

The standard device which provides the reference has been referenced to another device with higher accuracy that provides the verifiable value. This process involves a continuous and well documented chain until the known as primary standards, while the chain is called traceability.

Calibrations have the scope of maintain the correct function of instruments in order to satisfy the quality standards, normative requirements and instrument's traceability.

2.2.-Humidity sensor's calibration

A hygrometer is a sensor that can modify any physical property in function of humidity content in surrounding air, but anyone can answer, how can be ensured that any humidity sensor can offer a reliable measurement?, some additional information is needed –evidently- and can be obtained building a little camera where all conditions like temperature, humidity and pressure can be regulated. This is known as climatic chamber and is necessary to considerate very important aspects relative to the stabilization time to reach invariant conditions in time function.

The stabilization time t_s is influenced by several factors such as the climatic chamber's volume V_0 , characteristics of air circulation α , construction materials Mat , surface finish μ , outside temperature T_0 and the previous humidity level φ_{prev} .

$$t_s = t_s(V_0, \alpha, Mat, \mu, T_0, \varphi_{prev})$$

There's materials like plastic, rubber or nylon that should be avoided inside the climatic chamber because they tend to increase the stabilization time. In practice cases a commercial climatic chamber can be used to avoid the study relative to design and construction. Making this assumption the stabilization time shall be only function of outside temperature and the previous humidity level.

$$t_s = t_s(T_0, \varphi_{prev})$$

In the case of controlling relative humidity in the climatic chamber at different levels, the stabilization time will be directly proportional to the magnitude of humidity change $\Delta\varphi$, it is advisable that should be done stepwise and the sensors should be placed inside in order to minimize the interaction with outside ambient.

The objective of calibration process is to determinate the correction C_h that should be applied to the sensor under calibration, in other words the difference between the standard h_{ref} and the measured value from the instrument h_x . The reference can be given by a humidity generator that regulate the conditions inside the climatic chamber.

$$C_h = h_{ref} - h_x$$

The h_x value can be corrected by several factors δh_i .

The calibration process is described in the following schema:

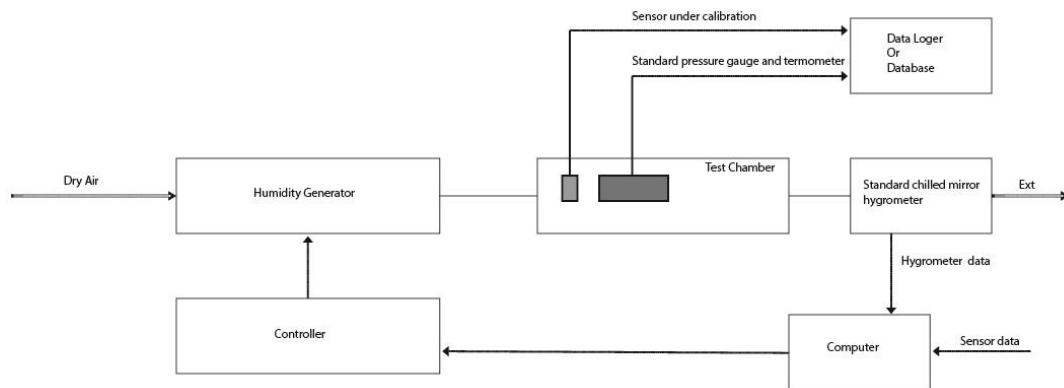

Figure 16 – Schematic calibration

The system shown in figure has a humidity generator fed with dry air and generates a controlled atmosphere in the climatic chamber where thermometers and sensors under calibration are totally immersed. From the climatic chamber data are collected and saved in database. Before being exhausted air passes through a standard chilled mirror hygrometer that collects, saves data and feeds a processor that commands the humidity generator's controller.

This system can be programmed to obtain wide enough stability ranges at desiderated conditions –Usually set in base of dew or frost point- and obtain stable state measurements at different levels of humidity automatically saving the data in a database in order to be analyzed.

2.3.-Example

In data 30/01/2015 was proceed with the calibration of two chilled mirror hygrometers, the system acquisition data had the following configuration:

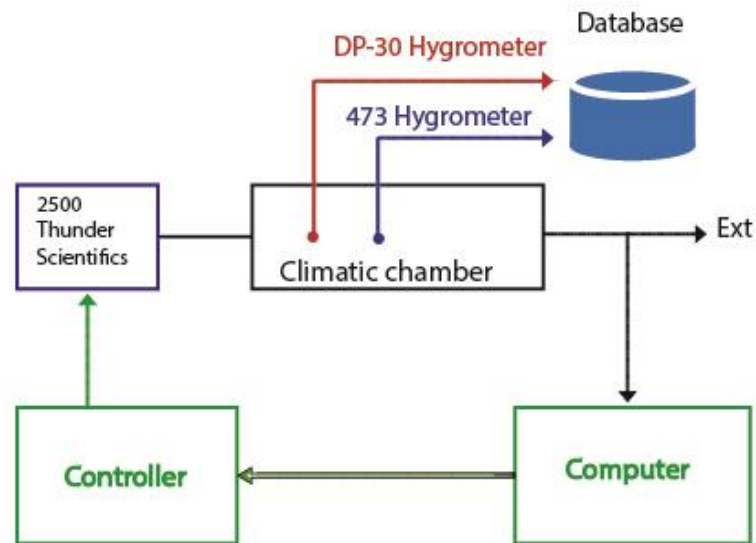

Figure 17 – Calibration system used

The sensors under calibration were two chilled mirror hygrometers, one model DP-30 manufactured by “MBW calibrations” and a 473 dew point mirror fabricated by RH-systems.

In the system was used a commercial humidity generator model 2500 from Thunder Scientific that regulates humidity inside an included climatic chamber where are placed two hygrometers.

Measurements was made every 5 seconds and saved in database while a programmatic routine in a computer commanded the humidity generator in order to obtain measurements automatically at different humidity levels –shown in dew point temperature-, for a good calibration wide stability intervals are needed.

Once the data has been obtained is proceed to graph the dew point temperature given by the generator in time function.

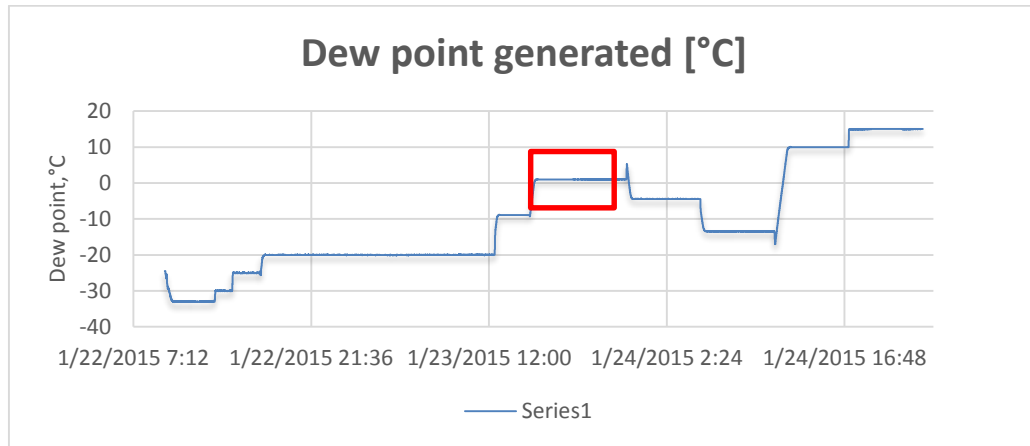

Graph 1 – Dew point graph

In the graph can be seen the different humidity levels at which the routine was programmed, is proceed to study every region and compare with the data coming from the sensors (the hygrometer under calibration and the standard). In the graph is selected the highlighted the region near from 0 °C.

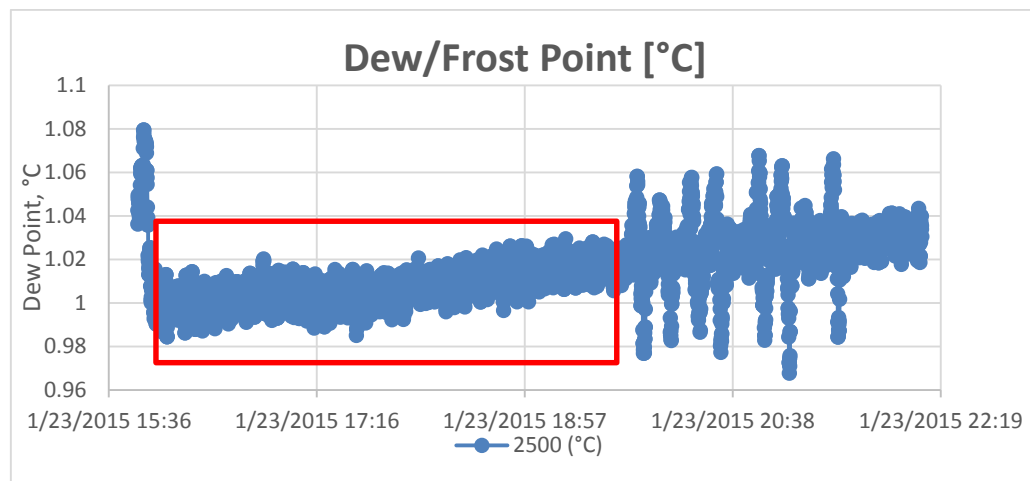

Graph 2 – Dew point along 1°C set point

From the graph we can notice two regions:

1. A transition region with random measurement behavior due to multiple factors such as the change from a humidity level to another and other ungovernable factors.
2. Stable regions that represent the valid dataset with which the calibration can be made, calculus relative to calibration demand for time stable conditions in the climatic chambers. The considered most stable region is highlighted on the graph.

Once we have selected the most stable region in the climatic chamber is proceed to compare the data with the measurements coming from the sensors at the same time intervals.

When one collect data from electronic devices is possible to have some problematic values that must be corrected or neglected, for example, the system data collector can seldom misinterpret the electrical signals adding a digit “1” to the lecture, in this case the extra digit must be erased.

Even more complicated is the automatic cleaning system of the chilled mirror hygrometers in which the mirror is heated periodically to clean any humid surface and contamination, the following graph shows the measured values of the MBW-DP30 hygrometer in the same time interval selected above:

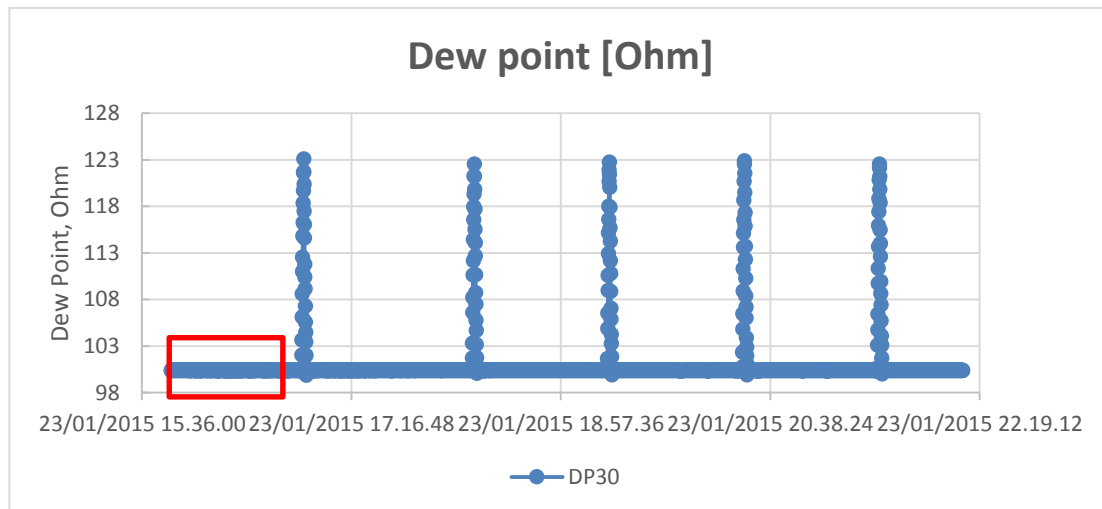

Graph 3 – Chilled mirror hygrometer measurements

One can notice the peaks where the mirror check process is performed, those values does not represent any useful information and should be neglected. Is proceed to select intervals –of around 10 minutes- where the measured data from the hygrometer is stable –It is important to pay attention to every chilled mirror hygrometer due to the cleaning system-.

Putting together in one graph the synchronous data from the two hygrometers and the conditions inside the climatic chamber one can see:

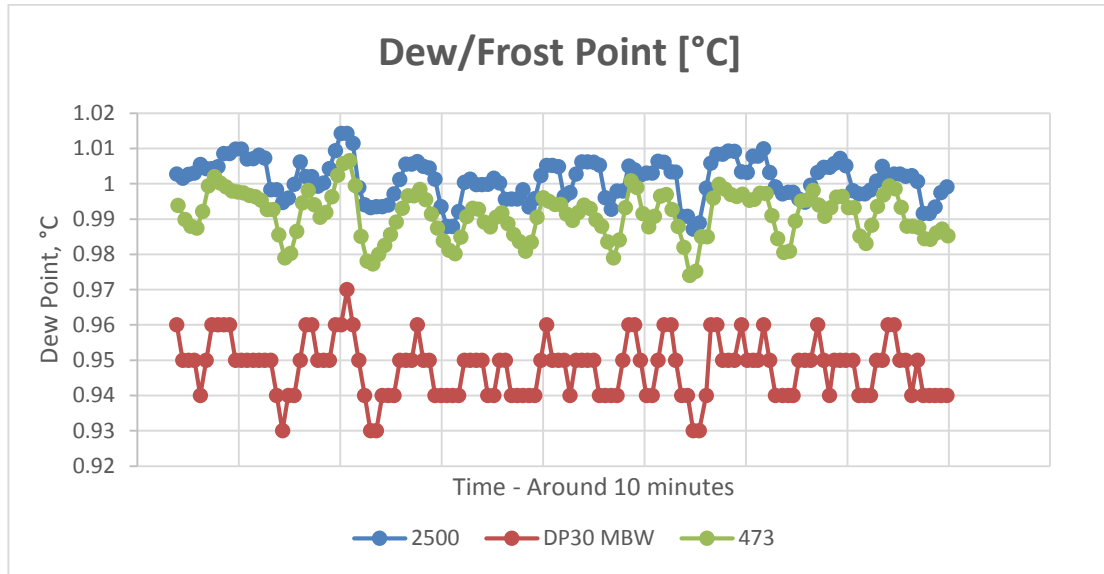

Graph 4 – Comparisson between the standard and the sensors

In the selected interval is observed the data from the humidity generator –blue- vary between 0.98 °C and 1.02 °C showing a good stability ideal for calibration purposes. The green curve shows the data measured by the standard and the red one corresponds to the hygrometer under calibration. Is noticeable the difference between the red curve respect to the standard and generator’s curves, the scope of this calibration is to minimize that difference.

The selection process should be done several times in order to collect as much information as possible at different levels of temperature where the data acquisition was programed. Once the selection step is finished is proceed to the analysis and calculation of uncertainties (type A).

The mean and the standard deviation can be calculated like:

$$\bar{x} = \frac{1}{n} \sum_{i=1}^n x_i$$

$$S^2(x) = \frac{1}{n-1} \sum_{i=1}^n (\bar{x} - x_i)^2$$

Consequently the deviation will be:

$$S^2(\bar{x}) = \frac{S^2(x)}{n}$$

The measurement's uncertainty will be $+S(\bar{x})$:

$$S(\bar{x}) = \frac{+S(x)}{\sqrt{n}}$$

$$u(x) = S(\bar{x}) = \frac{+S(x)}{\sqrt{n}}$$

In the appendix A is shown all the data including the mean and the standard deviation from the selected regions.

Is proceed to build a table with all the important information in which shall be shown the correction to be applied $\Delta T_{correction} = T_{2500} - T_{Sensor}$.

<i>Thunder Scientifics 2500 [°C]</i>		<i>DP30 Hygrometer [°C]</i>		<i>Generator Uncertainty</i>	<i>Correction ΔT</i>
<i>Media</i>	<i>Standard Deviation</i>	<i>Media</i>	<i>Standard Deviation</i>		
-25.003	0.001	-25.019	0.01	0.027	-0.016
-19.990	0.012	-20.015	0.01	0.023	-0.025
-10.010	0.003	-10.006	0.01	0.018	0.004
1.015	0.010	0.963	0.01	0.016	-0.052
9.975	0.003	9.919	0.01	0.015	-0.056
15.013	0.012	14.955	0.01	0.020	-0.058
29.995	0.006	29.929	0.01	0.016	-0.066
39.980	0.015	39.949	0.01	0.017	-0.031
50.004	0.009	49.962	0.01	0.019	-0.042
59.996	0.008	59.958	0.01	0.020	-0.038
64.989	0.015	64.936	0.01	0.021	-0.053
66.963	0.017	66.902	0.00	0.022	-0.061

Table 3 Correction for DP-30

The table below exposes the correction to be applied on every measure coming from the DP-30 hygrometer in order to obtain more accurate measures with respect of the standard. One can also use this data to use the instrument as a transfer standard and use the hygrometer as reference to other calibration process.

Analogously the following table is constructed for the 473 hygrometer.

<i>Thunder Scientifics 2500 [°C]</i>		<i>473 Hygrometer [°C]</i>		<i>Generator Uncertainty</i>	<i>Correction ΔT</i>
<i>Media</i>	<i>Standard Deviation</i>	<i>Media</i>	<i>Standard Deviation</i>		
-25.003	0.001	-25.03	0.01	0.027	-0.03
-19.990	0.012	-20.05	0.02	0.023	-0.06

-10.010	0.003	-8.88	0.01	0.018	0.03
1.015	0.010	1.01	0.01	0.016	0.00
9.975	0.003	9.96	0.01	0.015	-0.01
15.013	0.012	15.08	0.01	0.020	0.07
29.995	0.006	30.05	0.01	0.016	0.06
39.980	0.015	40.01	0.01	0.017	0.03
50.004	0.009	50.05	0.01	0.019	0.04
59.996	0.008	60.03	0.01	0.020	0.03
64.989	0.015	64.95	0.01	0.021	-0.04
66.963	0.017	66.90	0.00	0.022	-0.06

Table 4 Correction for 473 Hygrometer

In some cases the measures obtained from may vary under the same conditions, this is a very important aspect to take into consideration the instrument’s repeatability because can render useless the calibration performed.

An instrument with a good repeatability will show a relative soft calibration curve, in the graph below the red curve cannot be approximate by a logarithmic trend while the blue can be approximated without including high errors. This means that the 473 hygrometer –red- has not a good repeatability and the calibration uncertainty must be combined with an opportune factor u_{rep} .

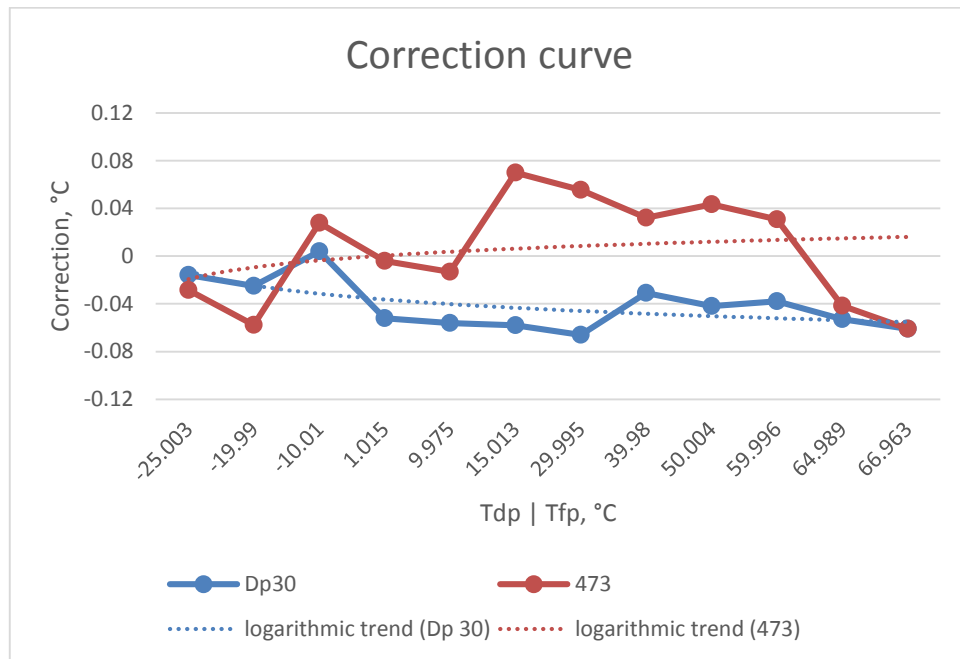

Graph 5 – Correction curve of DP-30 and 473 calibrations

The previous information does not include the combined uncertainty of the calibration process, is proceed to estimate the combined uncertainty using the following expression.

$$\begin{aligned} \text{Calibration Uncertainty} &= u_{cal}(T) \\ &= \sqrt{u_{2500}(T)^2 + u_{sensor}(T)^2 + std_{2500}(T)^2 + u_{rep}(T)^2} \end{aligned}$$

Where $u_{2500}(T)$ is the uncertainty related to the standard humidity generator and the pair $u_{sensor}(T)$ comes from the type A uncertainties estimation discussed previously.

The uncertainties related to the hygrometer’s repeatability are calculated assuming a uniform probability distribution is calculated the uncertainty as the respective standard deviation.

$$u_{rep-473} = \frac{|\max(\Delta T) - \min(\Delta T)|}{2 * \sqrt{3}} = 0.038 \text{ } ^\circ\text{C}$$

$$u_{rep-dp30} = \frac{|\max(\Delta T) - \min(\Delta T)|}{2 * \sqrt{3}} = 0.031 \text{ } ^\circ\text{C}$$

The tables of results are completed including the correction and combined calibration uncertainties calculated.

<i>Thunder Scientifics 2500 [°C]</i>		<i>DP30 Hygrometer [°C]</i>		<i>Generator Uncertainty</i>	<i>Correction ΔT</i>	<i>Calibration Uncertainty</i>
<i>Media</i>	<i>Standard Deviation</i>	<i>Media</i>	<i>Standard Deviation</i>			
-25.003	0.001	-25.019	0.01	0.027	-0.016	0.042
-19.990	0.012	-20.015	0.01	0.023	-0.025	0.042
-10.010	0.003	-10.006	0.01	0.018	0.004	0.037
1.015	0.010	0.963	0.01	0.016	-0.052	0.038
9.975	0.003	9.919	0.01	0.015	-0.056	0.036
15.013	0.012	14.955	0.01	0.020	-0.058	0.040
29.995	0.006	29.929	0.01	0.016	-0.066	0.036
39.980	0.015	39.949	0.01	0.017	-0.031	0.039
50.004	0.009	49.962	0.01	0.019	-0.042	0.039
59.996	0.008	59.958	0.01	0.020	-0.038	0.039
64.989	0.015	64.936	0.01	0.021	-0.053	0.041
66.963	0.017	66.902	0.00	0.022	-0.061	0.042

Table 5 - Calibration results for Dp-30 hygrometer

<i>Thunder</i>	<i>473 Hygrometer [°C]</i>		
----------------	----------------------------	--	--

<i>Sciendifics 2500 [°C]</i>				<i>Generator Uncertainty</i>	<i>Correction ΔT</i>	<i>Calibration Uncertainty</i>
Media	Standard Deviation	Media	Standard Deviation			
-25.003	0.001	-25.03	0.01	0.027	-0.03	0.048
-19.990	0.012	-20.05	0.02	0.023	-0.06	0.049
-10.010	0.003	-8.88	0.01	0.018	0.03	0.043
1.015	0.010	1.01	0.01	0.016	0.00	0.043
9.975	0.003	9.96	0.01	0.015	-0.01	0.042
15.013	0.012	15.08	0.01	0.020	0.07	0.045
29.995	0.006	30.05	0.01	0.016	0.06	0.042
39.980	0.015	40.01	0.01	0.017	0.03	0.045
50.004	0.009	50.05	0.01	0.019	0.04	0.044
59.996	0.008	60.03	0.01	0.020	0.03	0.044
64.989	0.015	64.95	0.01	0.021	-0.04	0.046
66.963	0.017	66.90	0.00	0.022	-0.06	0.047

Table 6 – Calibration results for 473 hygrometer

CHAPTER 3 - INDUSTRIAL APPLICATIONS OF HUMIDITY CONTROL

3.1.-Food Industry

Food production require to satisfy high quality and security standards where humidity control is one of the most important parameters in every sub-process inside alimentary industry, it is possible to group humidity control according to the type of sub-process:

- Control during the fabrication process:

In food industry is mandatory to follow a recipe that includes ingredients and instructions about how to process a mixture to guarantee good smell, taste or texture. Even more important is to standardize the final product which is a main aspect of big industries or alimentary franchises. Unfortunately, the taste is not the only one challenge to deal with, it is also important to ensure a product that respect all sanitary normative.

Louis Camille Maillard (1878-1936) was a French medic and chemist that studied the chemical reactions during the cooking process. It is known as Maillard reaction the set of reactions during food processing adding pleasant smell and taste. This reaction is responsible for the formation of the crust over the meat during cooking or the bread when baking, but it is also responsible for the synthetization of potentially harmful substances.

Acrylamides are chemical components formed during the Maillard reaction, its chemical formula is $CH_2 = CH - CO - NH_2$ and has toxic, neurotoxic and mutagenic properties, long exposition to acrylamides causes aging in several brain's regions specially the cerebral cortex, thalamus and hippocampus having negative effects in the memory, learning and other cognitive functions. In recent studies with rodents, males suffered fertility problems [14].

In april 2002 the Swedish National Food Authority with other researchers of Stockholm university announced that had found high levels of acrylamide in certain foods starch-rich that had been processed at high temperature like French fries, cookies or bread. The presence of acrylamide in starch-rich foods have

encouraged several researches in order to understand the formation process and which corrective actions can be applied.

In 2007 began the HEATOX project [15] where is proposed an acrylamide formation mechanism during Maillard reaction.

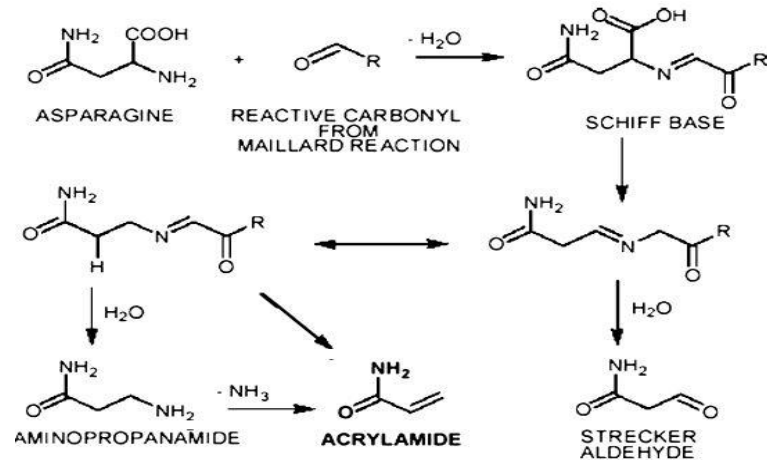

Figure 18 – Acrylamide formation mechanism during Maillard reaction

Acrylamides can also be produced from amino acids according to a process raised by Yasuhara in 2003 [16]

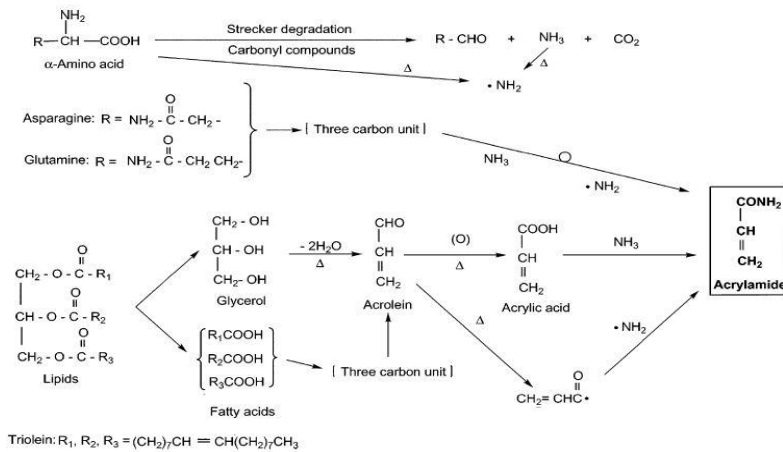

Figure 19 – Acrylamides can also be produced from amino acids according to a process raised by Yasuhara

Researchers from Ankara University [17] have defined the baking as a complex process moved by a heat temperature gradient with a simultaneous heat and mass transfer and determined that the major acrylamide concentration occurs along the crust.

Many strategies has been searched to avoid the acrylamides formation, either reducing the asparagine content or the addition of divalent cations, but the most efficient action was to maintain the water content above the 10% in any moment, the figures 20 and 21 show that the acrylamide formation process has more relationship to the crust formation process than any other phenomena.

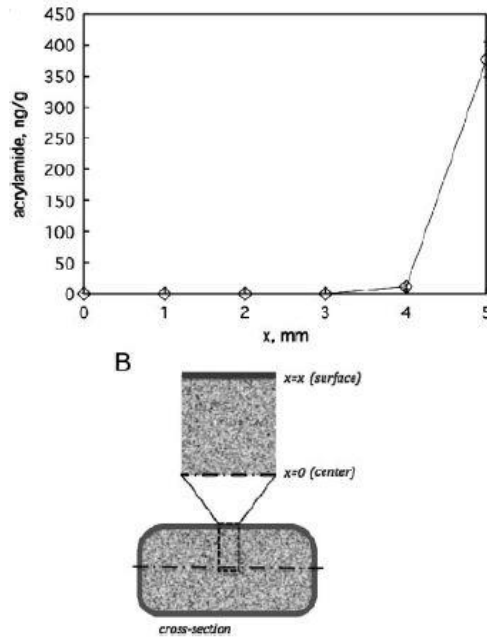

Figure 20 - The figure shows the acrylamide content along a cookie transversal section with 100mm width, baked by 200 °C for 15 min

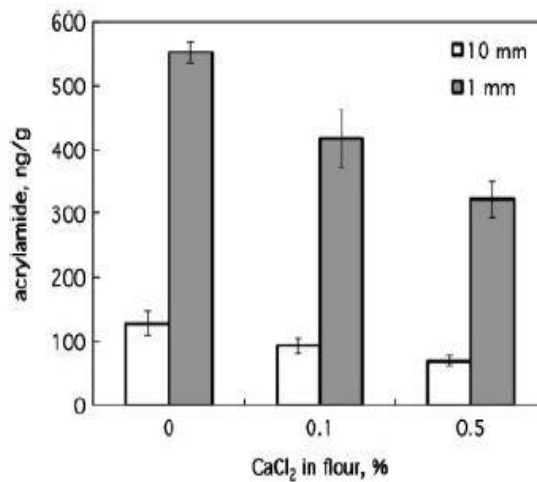

Figure 21 – The figure show the acrylamide content in function of the calcium chloride content in wheat

This research shows that is convenient to perform the baking process using a steam injection oven, representing an important application to humidity control in industry.



Figure 22 – Steam oven in action

- Conservation and food packing:

Water activity is one of the main factors that contribute to quality loss or deterioration; there may be necessary to control humidity for transport and stock, especially with foreign fruits that tend to loss quality quickly without a proper packing.

3.2.-Pharmaceutical industry

The pharmaceutical industry produces or synthesizes chemical products with medical purposes, to heal or prevent illness. The fabrication processes to synthesize those required chemical compounds must be controlled with high accuracy, and as the alimentary industry we could group in two the humidity control:

- Humidity control during fabrication process:

The cost structure of pharmaceutical laboratories is particular; they require raw materials –sometimes with high value- and fabrication process potentially complex and energetically expensive; this renders variable great part of the total production costs.

The fabrication process must be controlled with high accuracy, in the case of synthesize a different chemical product than the desiderated one, the consequences may be too negative, from great economic losses by fabricating a defective lot to putting in risk the health of many people. For this reason and considering the cost's structure, laboratories permits themselves the acquisition of high accuracy and cost instruments without having great impact in the final production's cost –instrument's cost have low specific weight-. In humidity measurement and control field, pharmaceutical laboratories can use chilled mirror hygrometers of high accuracy.

- Conservation and packing:

Similar to foods, medicaments tends to degrade their composition through time by mixing their composition with ambient contaminants or transmuting any chemical component to other, this phenomenon is highly unwanted and dangerous by their medical nature; however in most cases medicaments tends to loss their effectiveness.

Water activity is a key process of medicine's degradation, there will be a mass transfer between the ambient and the product until reach a thermodynamic equilibrium, which surely will not be the ideal for their conservation. Humidity must be controlled during the packing process to guarantee a controlled ambient inside the container.

In most cases the containers includes silica packs and cottons which absorbs humidity and keeping the product dry, this guarantee a longer preservation.

3.3.-Automotive Industry

One typical humidity control example present in the automotive industry comes when the coachbuilder painting process. In the case of humid air presence in the ambient –especially over the painting surface-, the painting will form bubbles over the surface and will tend to have pitting, to avoid this problem, the painting process should be realized in a dry chamber.

3.4.-Agriculture

Around the world there are many different ecosystems where lives a large variety of vegetal species, most of them with commercial interest, we have big leaf

plants which grows in tropical humid zones like Banana and Mango; plants with needles which grows in arid zones like Acacia and Cactus. However, is there any possibility to cultivate a foreign specimen in a specific country? There's a possibility to generate a controlled ecosystem where the plant can grow using a greenhouse. We define the plant stress as the difference between the natural ambient where the plant lives normally and the ambient where is being cultivated –The greenhouse-.

During day, plants do the photosynthesis process, absorbing carbon dioxide from the ambient and solar energy, throwing out oxygen. During night plants do only the breathing process, where they absorb oxygen and throw out carbon dioxide and water; this amount of water will increase the absolute humidity during night hours and represent a difficulty to create a controlled humidity ambient equal to their ideal, it is necessary a program that control the relative humidity in time.

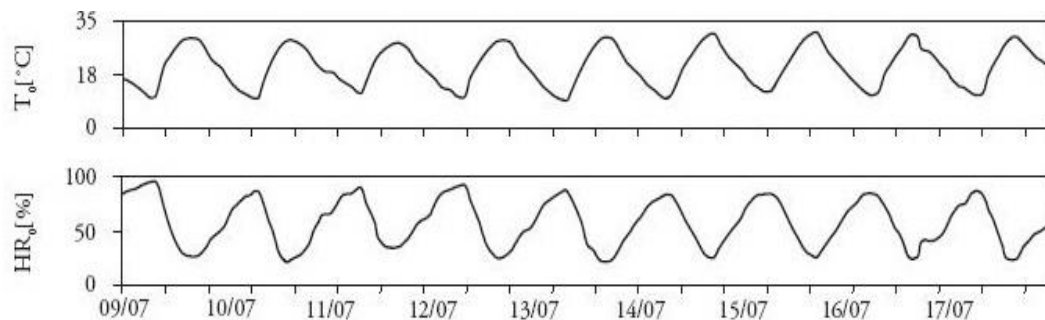

Figure 23 – Typical variation of relative humidity and temperature in a greenhouse during one week [18]

Inside the greenhouse the humidity parameter is not the only one who should be controlled, but surely is one of the most important; the minimization of the plant's stress has the advantage of boosting their growing and to avoid physiological problems or illness.

Other important aspect that should be considered when is desiderated to control humidity in a greenhouse is to create proper ambient for the pollination. Pollen is a group of particles that tends to create easily precipitates with water for forming non-Newtonian fluids, this phenomenon makes the pollination difficult when humidity reaches high values due to diverse reasons –one of them is the pollen contamination with other species like fungus or other species-. Is important to control humidity when reproductive periods to guarantee fertile pollen, and then guarantee a new generation of plants.

New technologies include programs that control the humidity automatically, improving the pollination with low relative humidity values%RH. Those greenhouses

can control the ambient even during the high temperatures typical from summer stations in templates areas.

3.5.-Air Conditioning

The objective of an air conditioning system is to generate a comfortable ambient for their occupants, it is often said the following: “an optimal acclimatization system is that able to generate a comfortable ambient without its functioning being detected”.

Low relative humidity values –less than 30%*RH*- generates dryness, irritations and allergies; and in severe cases infections caused by the mucous’ dryness.

With high relative humidity values, the enclosure will have a perfect ambient for fungus and other colonies; this will generate health problems to their occupants. One famous case was the Philadelphia Legionnaires disease outbreak, where in 1976 a group of war veterans were hosted in the Bellevue-Stratford hotel [1].

Other problem associated to high humidity levels is the blocking of one mechanism that has the human body to exchange heat. To maintain our corporal temperature stable –throw out heat- the human body has two mechanisms.

- Transpiration: Human body the skin pores liberates sweat to take out heat from the skin through its evaporation.
- Breathing: While breathing, our body frees water vapor that contains heat.

When relative humidity reaches high levels, the breathing mechanism reduces its efficiency –being blocked at 100% *RH* values- rendering uncomfortable the ambient.

3.6.-Nuclear Plants

Nuclear plants bases their functioning in the fission of unstable atoms commonly named “fissile material”, this fuel are placed in rods inside a reactor; during the fission process are liberated radiations which are highly dangerous which must be stopped, for this reason the reactor core has two containment barriers, the first is a vessel that contains the reactor, the second is a concrete building named “containment building”. Those barriers must stop any leak of highly radioactive material produced in the reactor.

The nuclear fission is a phenomenon where unstable atoms divide in two smaller atoms liberating big quantities of pure energy. Usually is a punctual and isolated process, but when a critical mass is reached –putting together fissile material- this process becomes a chain reaction liberating huge amounts of energy that should be extract from the reactor to maintain it stable.

There are two function schemas of nuclear reactor, one is called Boiling Water Reactor which passes liquid water from the bottom then evaporates and goes out from the top in steam phase, and the water flow refrigerates the reactor. The second schema is the Pressurized Water Reactor, which uses two water circuits, one at high pressure that passes through the reactor and a heat exchanger that evaporates the water in the second circuit.

In both schemas is water is bombed inside the reactor to maintain the temperature and produce steam which moves the turbines to generate electrical power.

The bombing process inside the reactor is extremely critical, being the failure of this system the principal cause of the biggest nuclear disasters happened in our history –Three Mile Island, Chernobyl and Fukushima- with perfectly known consequences.

It is possible to have eventual water leaks from the reactor vessel, being this an alert signal of a non-normal functioning; humidity sensors are placed inside the containment building with the objective to measure every humidity variation in the inner ambient, then if there are any increase of humidity, there may be a leak from the vessel and preventions must be taken.

3.7.-Museums

There are invaluable historical pieces to public exposed in museums, many of them are placed in reserved spaces which maintains a controlled ambient, separated from the visitor's ambient.

If we take as example a museum painting, it may be in contact with humidity present in air, and may exchange mass –humidity- with the surrounding, this process can degrade the colors' quality or even worse, can be exposed to humidity coming from visitor's breath contaminating the painting with bacteria and fungus which can easily degrade the painting. Wonderful artworks like The Mona Lisa are placed in reserved places where humidity can be adjust to the perfect value in which no humidity are being transfer between the art and the surrounding.

CHAPTER 4 - HUMIDITY STANDARDS

4.1.-Generalities and components

Humidity generators are systems that makes possible to generate well known thermodynamic states controlling humidity, temperature and pressure with the objective to have a reference for calibration process of humidity sensors.

There's diverse type of humidity generators, all of them have common elements such as:

4.1.1.-Pre-Saturator

It is a component built with a vessel, filled with distilled water and two air lines, the inlet line introduces dry air bellow the water level, the air is bubbled and the second line extracts air from the air above the water line.

This device has the scope of increase the humidity until a value close to saturation, without pre-saturator, the saturator component may have great dimensions and temperature gradients, increasing the uncertainties respect of the dew point temperature conditions generated.

The process is slow and the output line is placed in optimal place to avoid droplets flowing in the line that can have unwanted consequences related to the functioning stability.

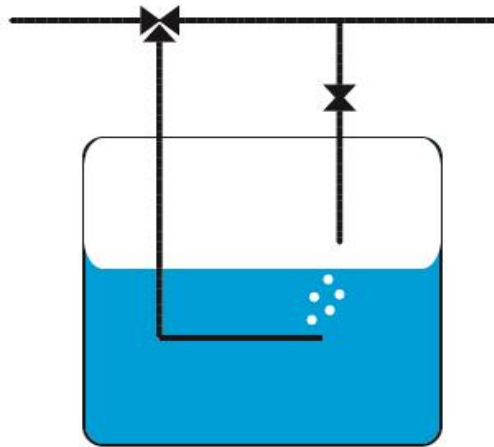

Figure 24 – Pre-saturator

4.1.2.-Saturator

The saturator is a chamber where air coming from pre-saturator passes through and reaches the saturation, absorbing water from the chamber. The saturator bases its operation on the Fick's law, which describes the diffusion phenomena:

$$j = \frac{\partial \dot{m}}{\partial A} = -D_p \frac{\partial P_v}{\partial y}$$



Figure 25 - Saturator

The amount of water vapor joined to the air flow is then:

$$\dot{m}_v = \int_A j * dA = \int_0^L j * b * dz$$

If the flow is saturated (is in equilibrium) this amount is $\dot{m}_v = 0$

A heat exchanger is placed before the saturator with the objective of approximate the air flow temperature as much as possible to the saturation chamber - about $1mK$ -, gradients are unwanted [25]. The following schema describes the system:

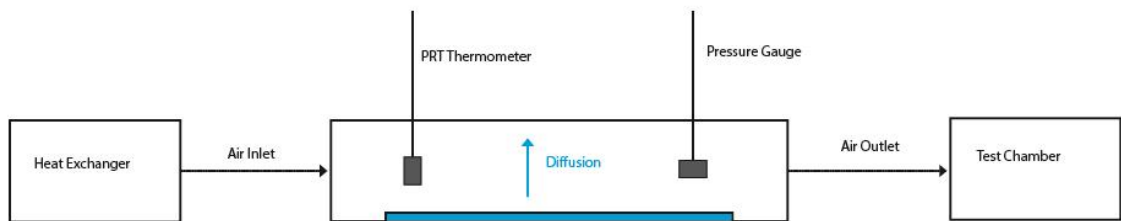

Figure 26 – Saturator system with measuring system

The National Institute of Standards and Technology –NIST- has a humidity generator which measures the temperature in the saturation chamber with a standard PRT thermometer placed in total immersion. Pressure is also measured with a silicon gauge [25].

4.1.3.-Flow Controller

Humidity generators are fed with air supply that provides the desiderated flow and should be regulated before passing through the pre-saturator.

A flow controller is a device used to measure and control a liquid or gas flow, they are usually designed and calibrated for a specific fluid and use to work between 10 and 90% from their total scale taking into consideration that extreme values are hard to regulate due to non-linearities. There are two typologies, digitals that can regulate more than one type of fluid, while analogs usually can only work with the fluid in which has been calibrated.

Usually a PID flow controller is placed before at the outlet of the air cylinder that feeds the humidity generator, in order to make possible to regulate the air flow. Divided flow humidity generators normally includes several flow controllers that allow the system to regulate the mixing rations.

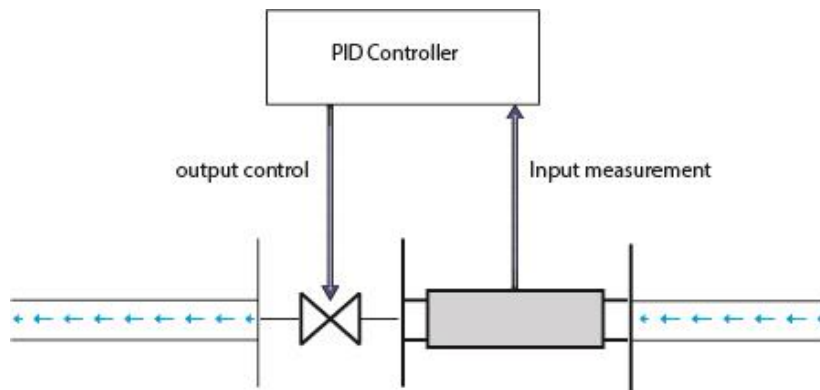

Figure 27 – figure of a typical flow controller

4.2.-Humidity Generators Typologies

4.2.1.-Two temperature humidity generators

Humidity generators made on the principle of two temperatures passes an air flow at constant pressure from a saturation chamber to a test chamber where the measurements are made. The cylinder provides an air flow at constant pressure.

The following schema shows a humidity generator developed at the INRIM previously known as istituto di Metrologia “G. Colonetti”, Turin, Italy.

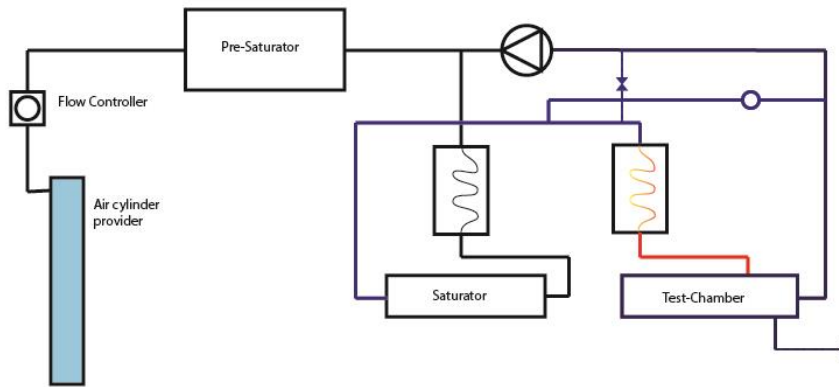

Figure 28 – Two temperature based humid gas generator

From the cylinder dry air flows to a pre-saturator device where increases its humidity, air is then passes through a saturation chamber where reach the relative humidity of 100%.

Once the air is saturated passes through a heat exchanger that increases its temperature to obtain the desiderated conditions of relative humidity.

4.2.1.1- Heat Exchanger

Through the hot side flows water from a controllable isothermal bath that transfers heat to the air flowing through the cold side, lowering the temperature to the bath's temperature.

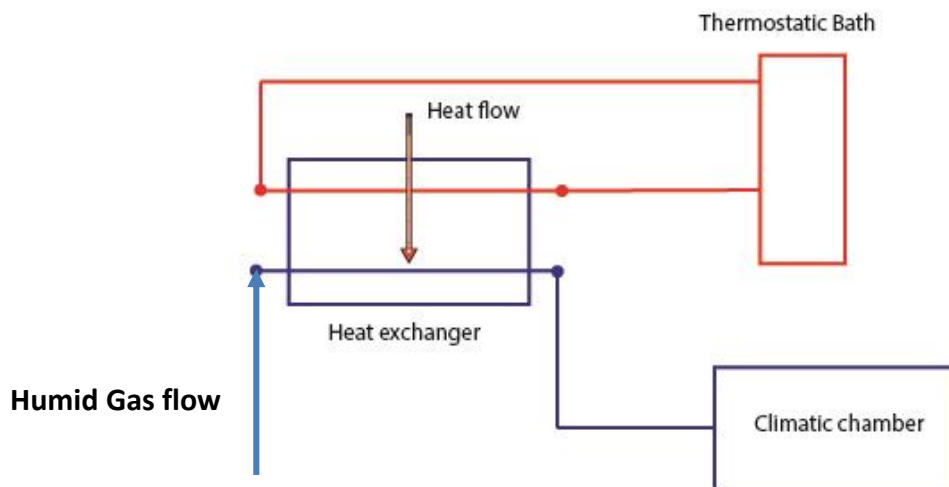

Figure 29 – Heat exchanger functioning schema

The relative humidity in the climatic chamber can be controlled varying the pre-saturation and isothermal bath temperatures. For stability reasons, to generate dew point values between -5 and 0°C , the pre-saturator temperature should be taken below -5°C to avoid metastable states of liquid water under congelation temperature.

4.2.2.-Two Pressure humidity generators

This type of humidity generator is based on the “principle of two pressures”. Air is supplied at high pressure from the cylinder to a pre-saturation chamber - controlling the mass flow-.

From pre-saturator air is passed to a saturation chamber where air reaches the saturation. Air pressure is then lowered controlling the flow –can be lowered using a PID throttle valve-, the process is made isothermally until reach the desiderated condition needed in the test chamber.

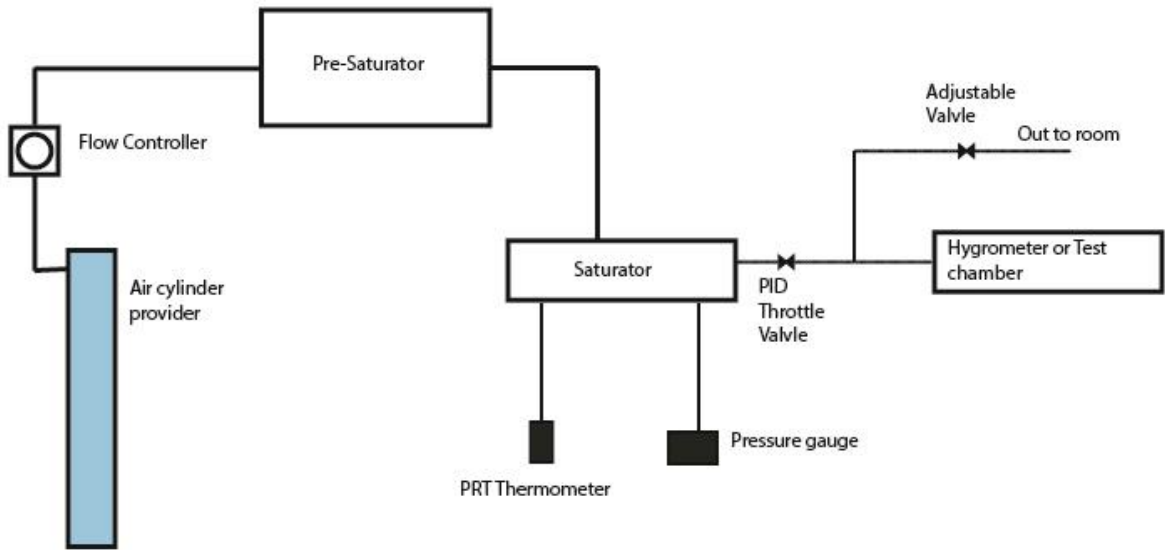

Figure 30 – Two pressures humid gas generator

The model 2500 is a humidity generator made by Thunder scientific corporation that works with two pressure principle; uncertainty given is dependent on the measurement’s accuracy and stability, hence:

$$\%RH = \frac{e_s(T_s) f(T_s, P_s)}{e_s(T_c) f(T_c, P_c)} * \frac{P_c}{P_s} \eta_s$$

Where the saturation pressure of the vapor is e_s , f is an enhancement factor dependent on the saturation temperature and pressure, η_s is the efficiency between the saturation's and test chamber's temperatures [26].

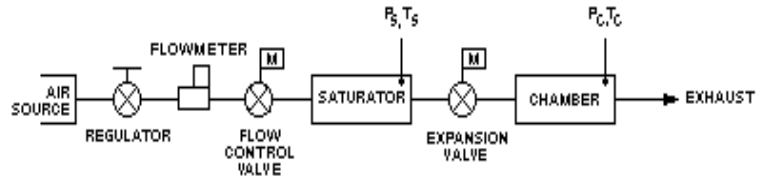

Figure 31 – elemental scheme of 2500 model

2500 model has the following characteristics:

Relative Humidity Range:	10 to 95 %RH
Relative Humidity Resolution:	0.02 %RH
Relative Humidity Uncertainty: @ P _c T _c *	0.5 %RH
Chamber Temperature Range:	0 to 70 °C
Chamber Temperature Range: (Optional)	-10 to +70 °C
Chamber Temperature Resolution:	0.02 °C
Chamber Temperature Uniformity: **	±0.1 °C
Chamber Temperature Uncertainty: *	0.06 °C
Chamber Pressure Range:	Ambient
Gas Flow Rate Range:	5 to 20 l/m
Gas Type:	Air or Nitrogen
Gas Pressure Rating (MAWP):	175 psiG
Heating/Cooling Rate:	2.5 Minutes Per °C Average
Chamber Window:	6" x 6" (152 mm x 152 mm)

Table 7 – Thunder scientifics 2500 chart

4.2.3.-Divided Flow humidity Generator

The divided flow method works mixing two flows, a saturated gas is mixed with a dry air flow in precise quantities.

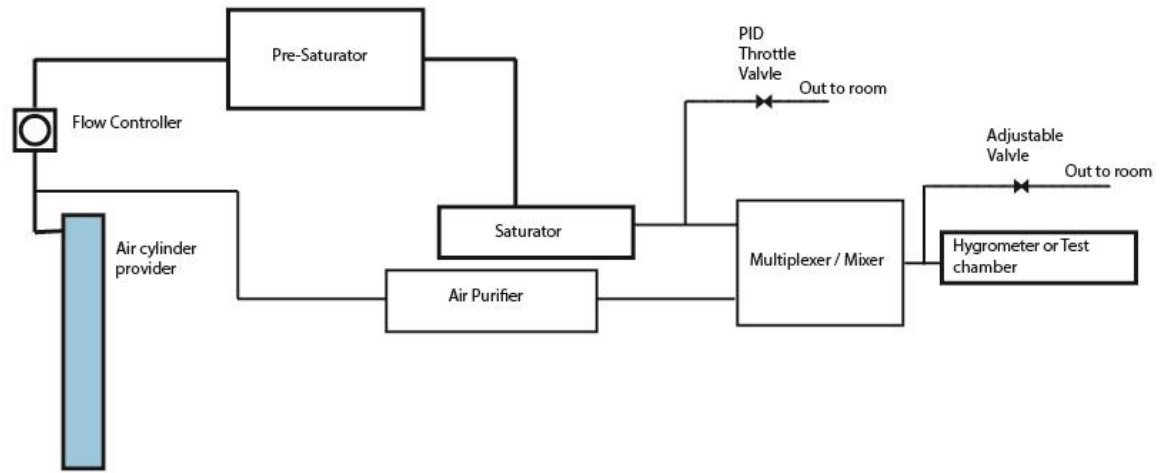

Figure 32 – Divided flow based humid gas generator

As the previous generator systems, air flows from the air supply -cylinder-. This cylinder provides dry air that is divided into two, one flows (1) to an air purifier and the second (2) goes to a mass flow controller.

The second flows is controlled and passed to a pre-saturator device –described previously- then goes to a final saturator when reaches the saturation $\phi = 100\%$, this flow goes then to a multiplexer where is mixed with the dry air flow coming from the air purifier (1).

Inside the multiplexer the two flows are diluted at well-known quantities in order to know the final hygrometric conditions. The mole fraction after dilution is:

$$x = \frac{\dot{n}_s x_s + \dot{n}_p x_p}{\dot{N}}$$

Where \dot{n}_s and \dot{n}_p are the molar flow rates of the saturated gas and pure gas, respectively, and \dot{N} is the total molar flow rate. Also, x_s is the mole fraction of water in the pure gas. This allows generation of arbitrarily low humidity values while operating the saturator at convenient temperatures.

The dew-point temperature T_{DP} and frost-point temperature T_{FP} are obtained from the mole fraction by iteratively solving equations,

$$\begin{cases} x = \frac{e_w(T_{DP})}{P_c} f(T_{DP}, P_c) \\ x = \frac{e_i(T_{FP})}{P_c} f(T_{FP}, P_c) \end{cases}$$

Where $e_w(T_{DP})$ and $e_i(T_{FP})$ are the saturated vapor pressures of water and ice at the dew point and the frost point, respectively. The relative humidity is determined by:

$$RH = \frac{xP_c}{e(T_c)f(T_c, P_c)}$$

Where T_c is the temperature in the chamber (or environment) where the humidity is being determined, and $e(T_c) = e_w(T_c)$ for $T_c \geq 0 \text{ }^\circ\text{C}$ and $e(T_c) = e_i(T_c)$ for $T_c < 0 \text{ }^\circ\text{C}$ [30]

CHAPTER 5 - DEVELOPMENT OF PORTABLE HUMIDITY GENERATOR AT HIGH TEMPERATURE AND HUMIDITY

5.1.-Development of portable humidity generator at high temperature and humidity

In industry there are used several type of humidity sensors that must be calibrated periodically, however, humidity generators are systems whose construction and size render difficult their suitability to every application. Many generators are design to work at atmospheric pressures or slightly above, many fields require humidity sensors' calibrations at high pressure and/or temperature.

The disadvantages previously mentioned has motivated the design and development of a portable humidity generator with performance similar to laboratories, the design uses a corrugated plate heat exchanger -**PHE**- which has the great advantage of having reduced volume making the system compact.

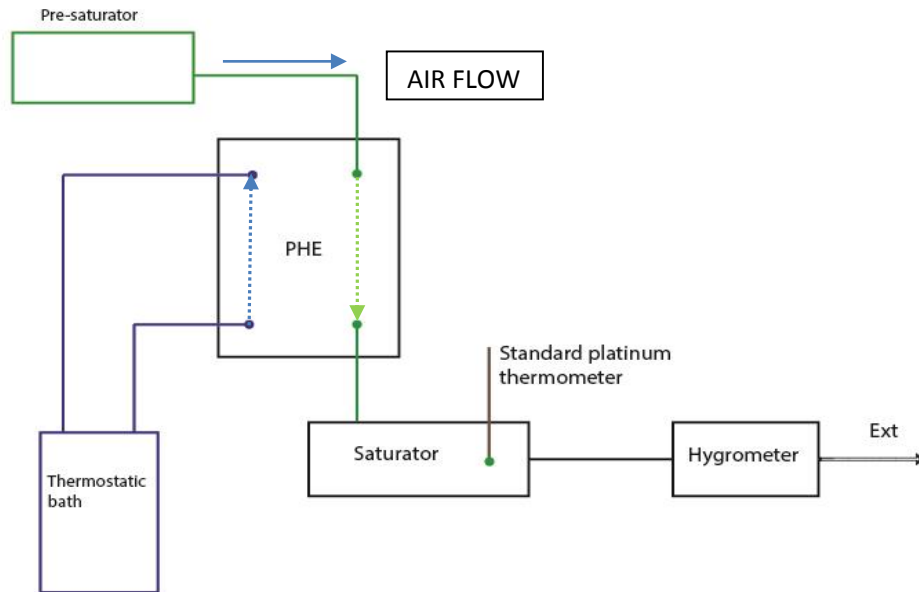

Figure 33 – PHE-Based humid gas generator schema

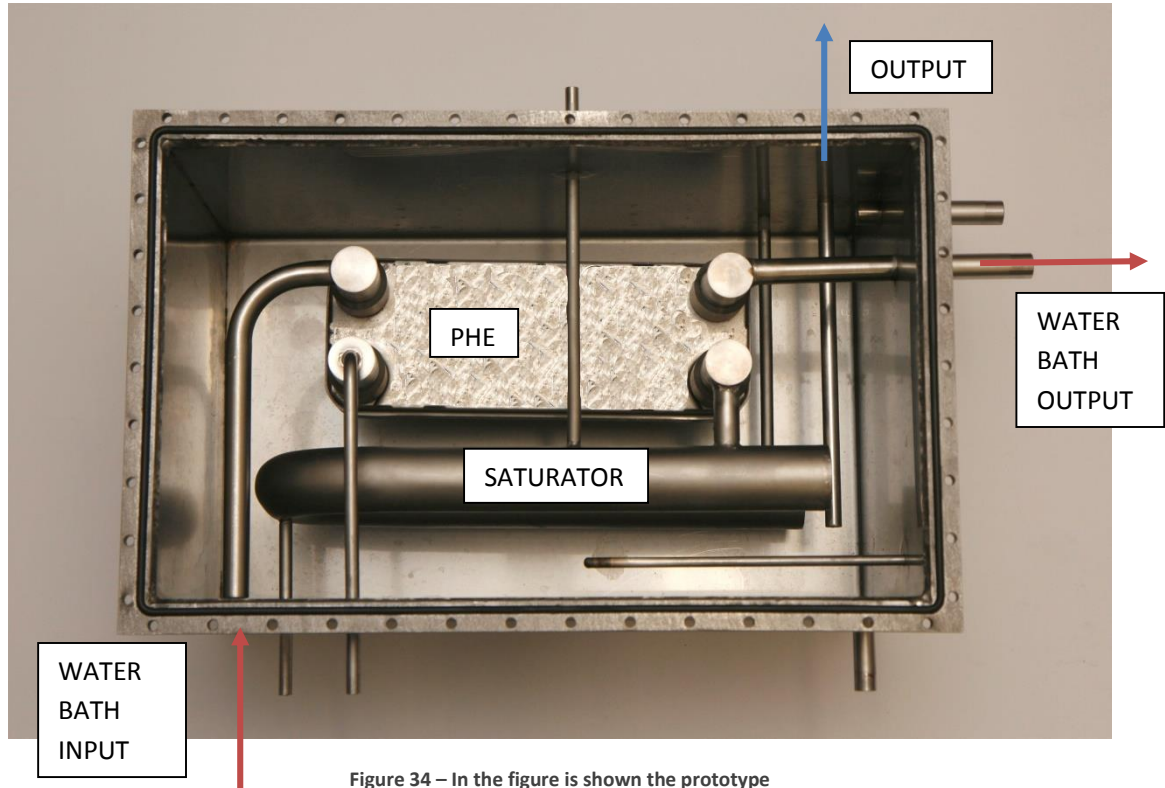

Figure 34 – In the figure is shown the prototype

In the appendix B are shown a group of pictures of the constructed prototype.

5.2.-PHE Description

The preliminary design includes a commercial humidity generator -CHG- that provides air to the system for only testing purposes, is going to be substituted by a bubbling pre-saturator. Air is then passed through the “hot” side of the PHE where transfers heat to the water passing along the cold side supplied by a thermostatic bath.

The PHE as many other heat exchangers, is a component that increases heat transfer between two fluids at different temperatures without physical contact. Depending on the direction the fluids pass through, there can be two situations:

1. **Co-current:** cold fluid enters in parallel with the hot fluid, at the heat exchanger output both fluids will be approximately at a weighted average temperature.



Figure 35 – Direct flow heat exchanger

2. **Counter-current:** Cold fluid enters in contact with the output of the hot fluid, heating along the heat exchanger and leaving with approximately the hot fluid's input temperature.



Figure 36 – Counter flow heat exchanger

Heat exchangers try using big contact areas to maximize the heat transfer between two fluids, using this affirmation the key parameter to describe them is the “Heat exchange area” that can be related with heat exchanged and other functional parameters using the following equation:

$$A = \frac{\dot{Q}}{U_D * \Delta T_{ml}}$$

One can build a heat exchanger putting in parallel several corrugated plates bonded in pressure with rubber elements inserted between plates or just welded to avoid any leakage. Every hot fluid passes interleaved with cold fluids and the corrugated form maximizes the heat exchange area and creates turbulent flow which increases the performance.

The model uses a heat exchanger model AlfaLaval model AlfaNova 14 of 10 plates working as condenser, where 5 “hot” air channels are interleaved with 5 cold

water, the manufacturer indicates that the operation interval comes from -180 to 220°C with a max pressure of 2.3 Mpa [33].

Plate Heat Exchanger (PHE)

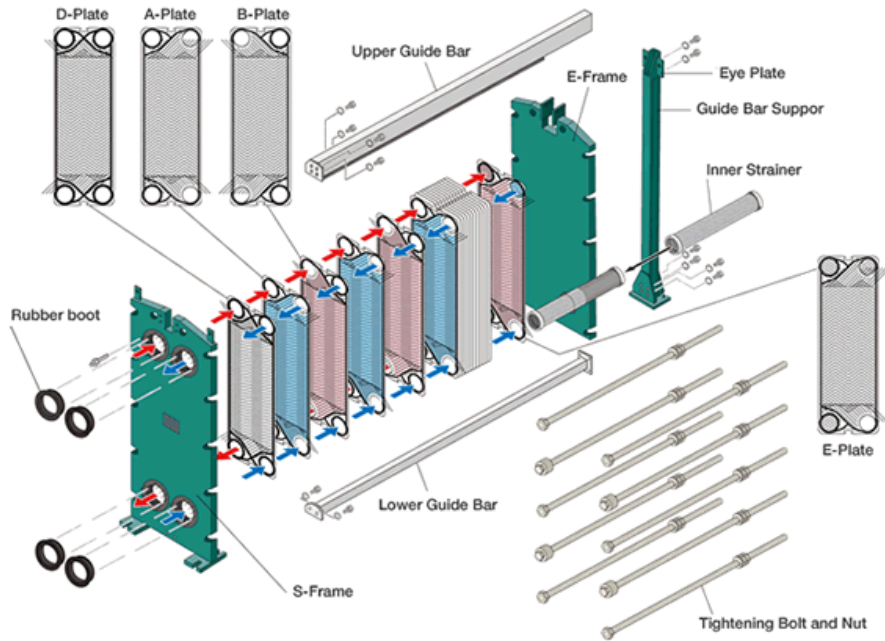

Figure 37 – Plate Heat exchanger construction schema

Along the hot side of the PHE air passes through lowering its temperature until isothermal bath's temperature, which is nearly the saturation temperature $T_{bath} \approx T_{sat}$ condensing over the plates surface.

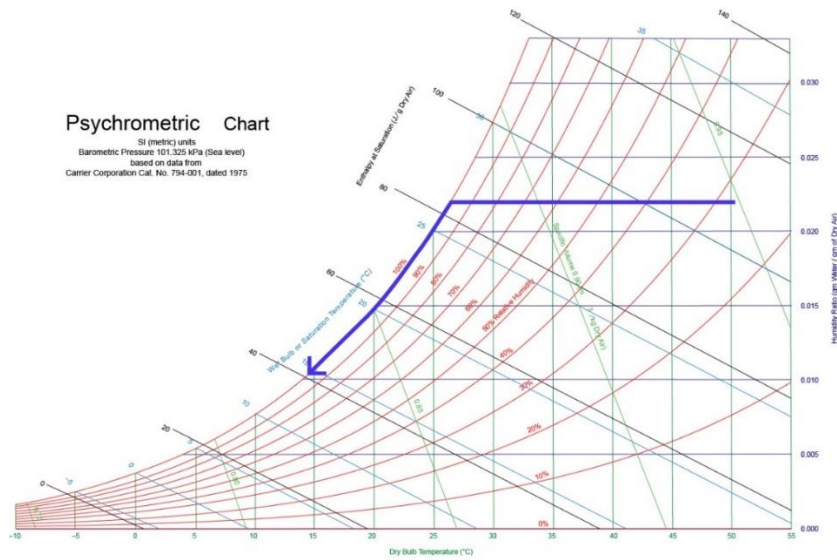

Figure 38 – Along the heat exchanger the air will perform a cooling with dehumidification

One of the main drawbacks of using a PHE is the relative high pressure drop when the fluid passes through the narrow channels, in our application can increase unacceptably the uncertainties of outlet dew point temperature.

Some studies about the condensing phenomena over the plate’s surface have been done where is shown a direct relationship between the flux ϕ and the quantity of water condensing along the plates x respect to the pressure drop Δp [4] [5].

$$f(\phi, x) \propto \Delta p$$

5.3.-Preliminary testing

5.3.1.-Pressure drop along the PHE test

To ensure the feasibility of using PHE in the humidity generator respect to the pressure drop, have been designed a preliminary tests to determinate the pressure drop along the heat exchanger Δp_1 under diverse extreme conditions where the system is expected to operate.

Have been added a differential pressure gauge manufactured by Datametrix with a full scale of 10 Torr, as shown in figure:

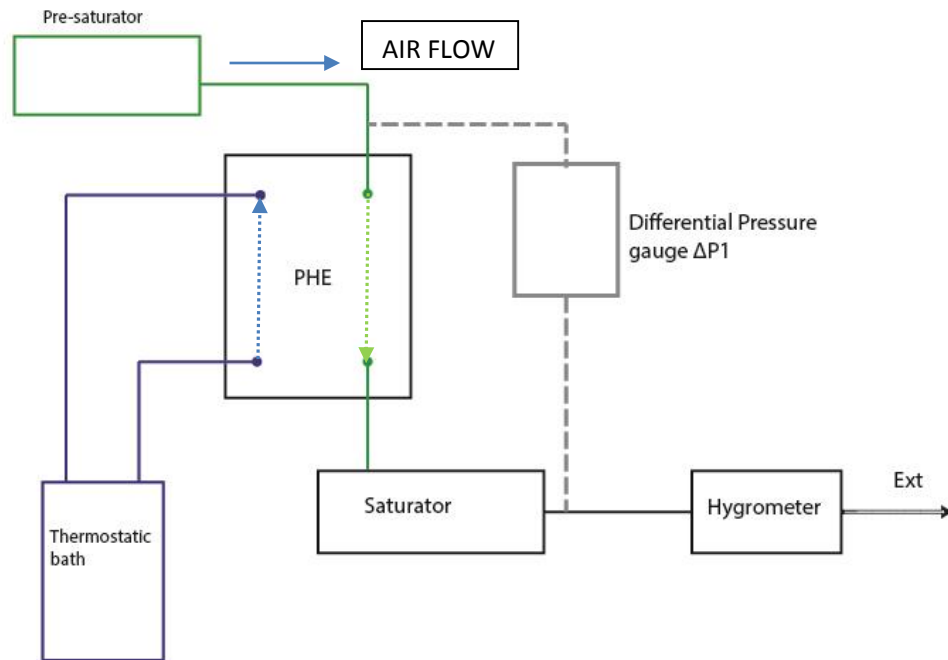
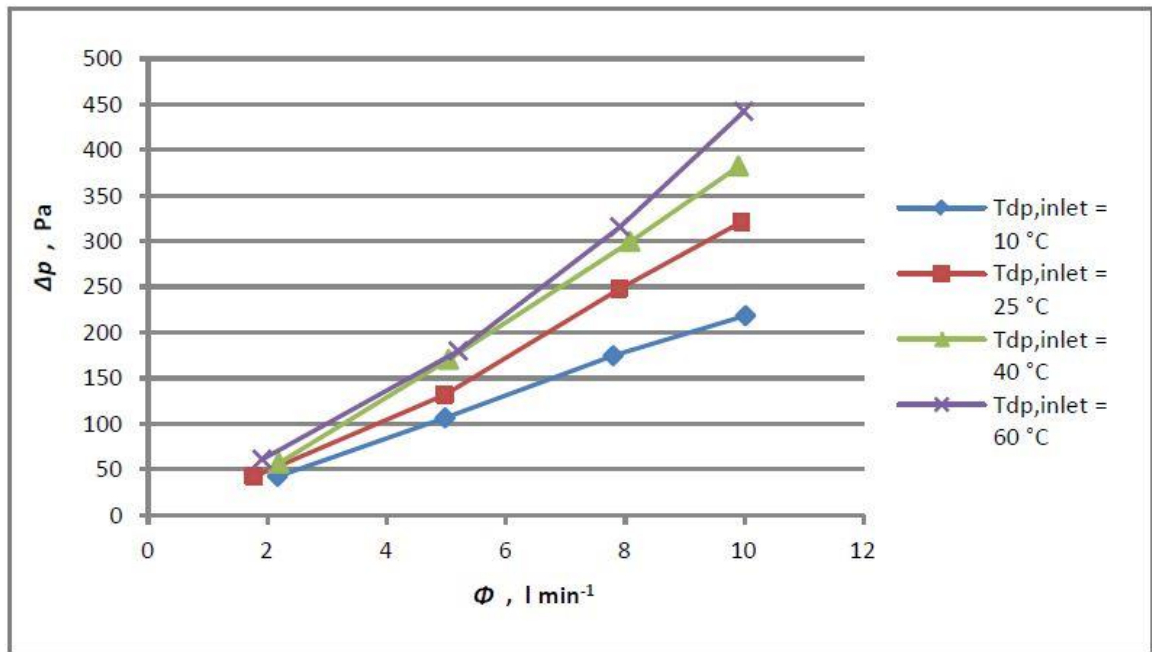

Figure 39 – Pressure drop test along the humid gas generator

The test have been done varying the PHE inlet temperatures $T_{dp,inlet}$ and the air flow having the following results [32]:



Graph 6 – Pressure drop along the humid gas generator

As expected the pressure drop is directly proportional to the flow and the inlet temperature, having an extreme $\Delta p = 440 Pa$ corresponding to a flow of $10 \text{ liter}/\text{min}$ and $T_{dp,inlet} = 55^\circ\text{C}$, which corresponds to an error of -0.06°C in the outlet dew point temperature, however under more realistic conditions where is expected to work the pressure drop will be under $160 Pa$ which would generate an error not superior of -0.02°C .

5.3.2.-Saturation tests

The operation of a PHE is influenced by the position in which is installed, research made by [37] indicates that a Plate heat exchanger working as a condenser can optimize its functioning being installed in horizontal position, increasing the heat exchange coefficient between 17 and 30% respect to the vertical position due to the minimization of condensing length.

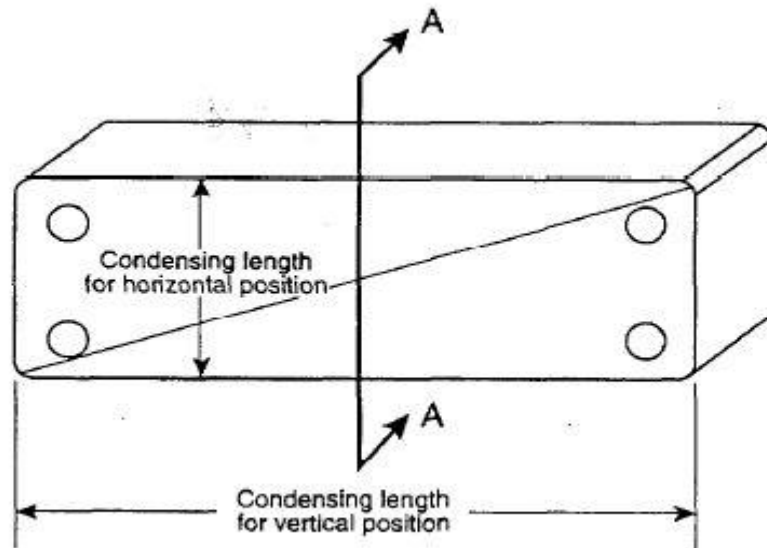

Figure 40 – Evaporator position

After passing through the saturator the air flows to the saturator where reaches the relative humidity of 100% and starts to condensate water over the plate's surfaces keeping constant the temperature acquired from the evaporator, which is approximately the bath's temperature $T_{sat} \approx T_{bath}$. The humidity generator efficiency is based on the capacity to fully saturate the gas at the desiderated temperature T_{bath} .

The saturator is composed by a container partially filled with water, air flows through the superior side fully saturating the gas flow thanks to the diffusion phenomena. It is placed a standard PRT-100 thermometer that reads the air's flow temperature, called saturation temperature T_{sat} .

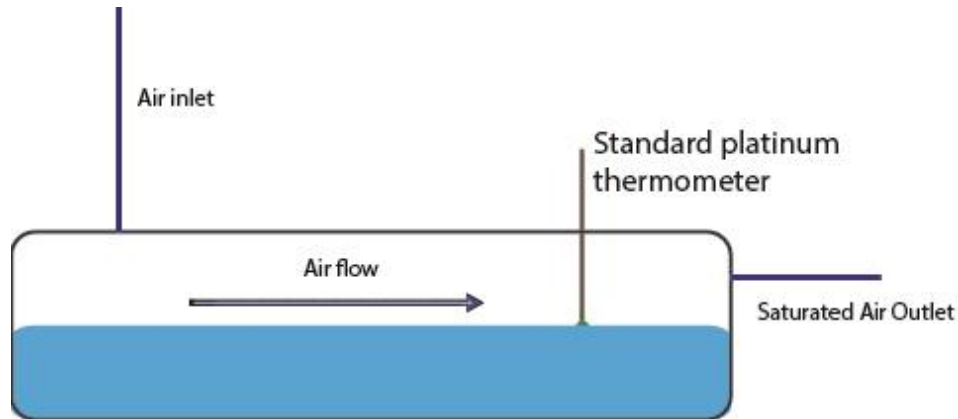

Figure 41 – Saturation construction

The saturator's output air flow is studied to determinate the capacity to fully saturate the gas, three preliminary tests have been designed in which the system work under normal and extreme conditions:

1. PHE in vertical position with the following conditions:
 - Saturator temperatures $T_{bath} \approx T_{sat}$ de 1°C, 15°C, 25°C, 40°C and 60°C.
 - Pre-saturador (inlet dew-point) temperature $T_{dp,inlet} = T_{sat} + 5^\circ\text{C}$
 - Gas flow rates at the PHE inlet set to: $\emptyset = 2 \text{ l/min}, 4 \text{ l/min}, 8 \text{ l/min}$ y 12 l/min .
2. PHE in vertical position with:
 - Constant saturator temperatures $T_{sat} = 5^\circ\text{C}$
 - Pre-saturador (inlet dew-point) temperature: $T_{dp,inlet} = 0^\circ\text{C}, 10^\circ\text{C}, 30^\circ\text{C}$ y 60°C .
 - Gas flow rates $\emptyset = 2 \text{ l/min}, 4 \text{ l/min}, 8 \text{ l/min}$ y 12 l/min .
3. PHE in horizontal position with:
 - Saturator temperatures $T_{sat} = 1^\circ\text{C}, 25^\circ\text{C}, 40^\circ\text{C}$ and 60°C .
 - Pre-saturador (inlet dew-point) temperature $T_{dp,inlet} = T_{sat} + 5^\circ\text{C}$.
 - Gas flow rates $\emptyset = 2 \text{ l/min}$ and 4 l/min .

The first test was performed to determinate the total efficiency of the system, for example the capacity of the system to fully saturate the gas in the operational range that is expected to be used varying the air flows.

The second test was designed to evaluate the efficiency of the PHE as a condenser and the possibility to work increasing the heat load, the functioning is evaluated increasing the pre-saturator temperature beyond the +55°C.

The third test is similar to the first but rotating the condenser from the vertical to the horizontal position with the scope of validate that an efficiency improving so that the system can be optimized and build in a more compact and portable way.

5.3.3.-Pressure drop along hygrometer's air line

The humidity generator's output is a saturated air flow, which is passed through an airline and tested with a standard chilled mirror hygrometer. To avoid any condensation inside the line, is coated with a thermal hose. Unfortunately this line includes an error in the dew point temperature measurement due to a pressure drop.

The following test is designed to know the pressure drop varying the air flow and the saturation temperature.

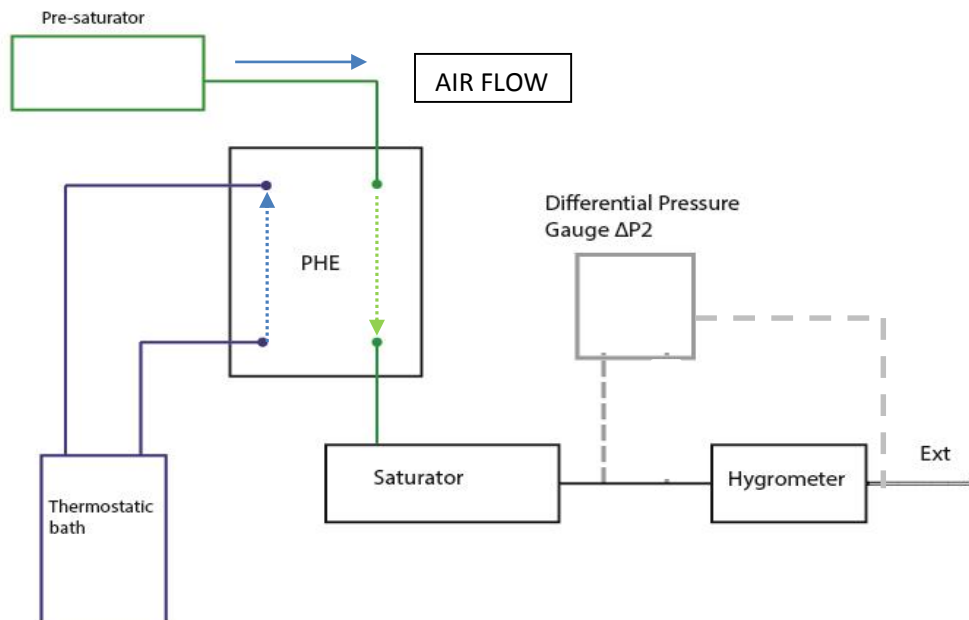

Figure 42 – Pressure drop test along the thermal hose between the saturator and the hygrometer

In the figure is highlighted the system used to calculate the pressure drop Δp_2 along the line using the same differential pressure gauge from the previous test.

$T_{sat} [^{\circ}C]$	$\phi [l/min]$	$T_{line} [^{\circ}C]$	Pressure Drop [Pa]	Correction $\delta_T [^{\circ}C]$
1	2	25	144	0.02
1	2	60	275	0.04
1	2	30	233	0.03
1	4	30	411	0.06
1	4	60	463	0.06
1	4	90	531	0.07
10	2	25	137	0.02
10	4	25	357	0.05
20	2	25	144	0.02
20	4	25	359	0.06
30	2	50	167	0.02
30	4	50	413	0.07
40	2	70	268	0.05
40	4	70	536	0.1
50	2	80	208	0.04
50	4	80	527	0.11
60	2	100	296	0.06
60	4	100	692	0.15

Table 8 – Resume of the pressure drop along the line with the respective correction

In the table 5.1, is resumed the typical pressure drop respect of the air conditions along the line, including the respective correction that should be applied. This correction is calculated using the software HumiCalc [38].

The uncertainty of the differential manometer is neglected due to the influence on the correction δ_T is around $10^{-4} K$.

$$\delta_T(692 Pa) - \delta_T(702 Pa) \sim 5 \times 10^{-4} K$$

The correction on the dew point measured should be done using the following expression:

$$T_{CMH} = T_{Higr} + \delta_T$$

The agreement between T_{sat} and T_{CMH} demonstrate the system's ability to fully saturate the air at the set-point temperature.

5.4.-Validation of the Humid Gas Generator Prototype

5.4.1.-Generalities

The prototype HG will be validated through a comparison process against a standard HG (Thunder Scientifics 2500) using a high precision hygrometer as transfer instrument.

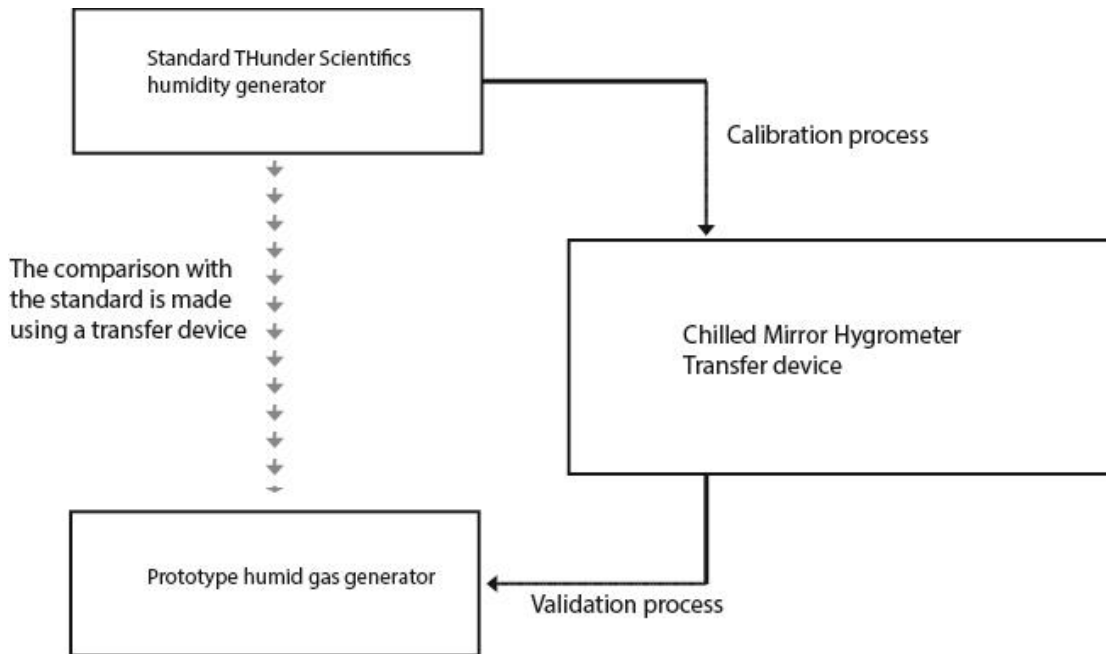

Figure 43 – Validation schema

There have been performed several tests to validate the agreement between the saturation and dew point temperatures. One can evaluate those states as the difference.

$$\Delta T = T_{CMH} - T_{sat}$$

The temperature inside the saturator is ideally equal to the dew point measured with the chilled mirror hygrometer, the performance of the humid gas generator will be validated if the difference ΔT plus the combined uncertainty contains the zero value, consequently is proceed to estimate the combined uncertainty of the temperature difference.

With respect of the preliminary system, the following changes were made to the experimental apparatus:

- The commercial humidity generator was replaced by a pressure –and temperature- controlled bubbling pre-saturator equipped with a cartridge heater and a PID controller. In the figure below is shown the installation example of the Red-Y Smart Controller used given by the manufacturer [39].

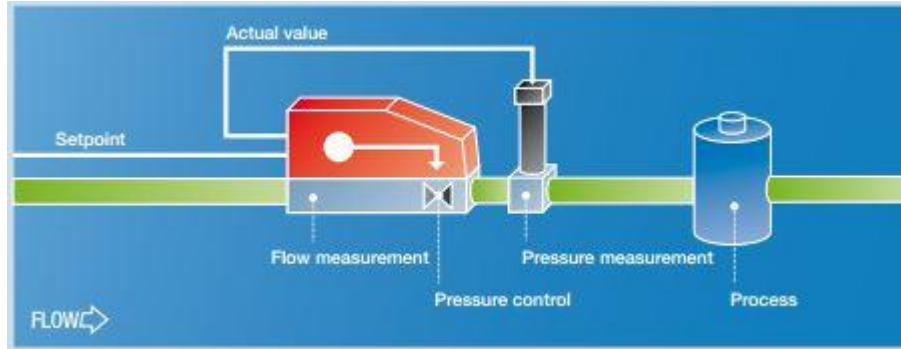

Figure 44 – Flow controller installation example

- The Chilled mirror hygrometer was replaced by another able to operate at pressures up to 2Mpa .
- A double-diaphragm forward pressure regulator was inserted between the inlet gas from a high-pressure cylinder and the pre-saturator in order to ensure a stable pressure operation above 1 atm .
- An absolute pressure transducer (MKS Baratron, 1.33 Mpa f.s.) was connected to the pre-saturator inlet to monitor the system pressure.

5.4.2.-Estimation of combined uncertainty

Previously has been discuss that the quantity $T_{CMH} - T_{sat}$ is the comparison between the generated saturated flow and the dew point temperature detected by a hygrometer whose traceability is well known respect humidity measurement standards.

To evaluate the standard combined uncertainty $k = 1$ associated to the measurement, the components to take into account will be:

- The combined uncertainty calibration including the 2500 thunder scientific humidity generator’s uncertainty and the standard deviation of the hygrometer used.
- The uncertainty related to the hygrometer’s repeatability.
- The generator’s standard deviation.

- The standard PRT-100 uncertainty that measures the T_{sat} temperature combined with the standard deviation.

The standard uncertainty was estimated assuming statistical independence respect of the temperature and as consequence adding their variances:

$$u(T_{CMH} - T_{sat}) = \sqrt{u(T_{CMH})^2 + u(T_{sat})^2}$$

It is necessary to calculate the following components:

- The chilled mirror hygrometer uncertainty $u(T_{CMH})$
- The saturation temperature uncertainty $u(T_{sat})$

5.4.2.1.-Chilled mirror hygrometer uncertainty

In the validation's schema is shown a standard humidity generator (Thunder Scientifics 2500) used to calibrate a hygrometer model Michell Optidew Vision following the same comparison procedure described in the calibration chapter, obtaining the following results resumed in the table:

<i>Thunder Scientifics 2500 [°C]</i>		<i>Michel Hygrometer [°C]</i>		<i>TS 2500 Generator Uncertainty [°C]</i>	<i>Correction δ_T [°C]</i>	<i>Calibration Uncertainty [°C]</i>
<i>Media</i>	<i>Standard Deviation</i>	<i>Media</i>	<i>Standard Deviation</i>			
0.001	0.005	0.012	0.004	0.015	0.011	0.054
5.002	0.005	4.998	0.003	0.026	-0.004	0.058
9.999	0.007	9.981	0.005	0.023	-0.018	0.057
14.993	0.005	14.962	0.004	0.020	-0.031	0.056
19.997	0.024	19.928	0.004	0.019	-0.070	0.060
24.934	0.015	24.349	0.011	0.023	-0.045	0.059
29.999	0.004	30.024	0.011	0.021	0.024	0.057
34.975	0.009	35.083	0.008	0.021	0.108	0.057
39.996	0.008	40.071	0.013	0.023	0.076	0.058
44.935	0.008	45.061	0.016	0.024	0.067	0.059
49.993	0.011	50.008	0.008	0.021	0.015	0.057
54.985	0.009	54.959	0.008	0.021	-0.027	0.057
59.970	0.011	59.922	0.008	0.022	-0.048	0.058
64.996	0.032	64.938	0.021	0.030	-0.058	0.071

Table 9 – Michell hygrometer calibration results

Following the same procedure, the hygrometer's repeatability was analyzed plotting the calibration curve observing that the Michell hygrometer has poor repeatability respect to other models like DP-30 or 473.

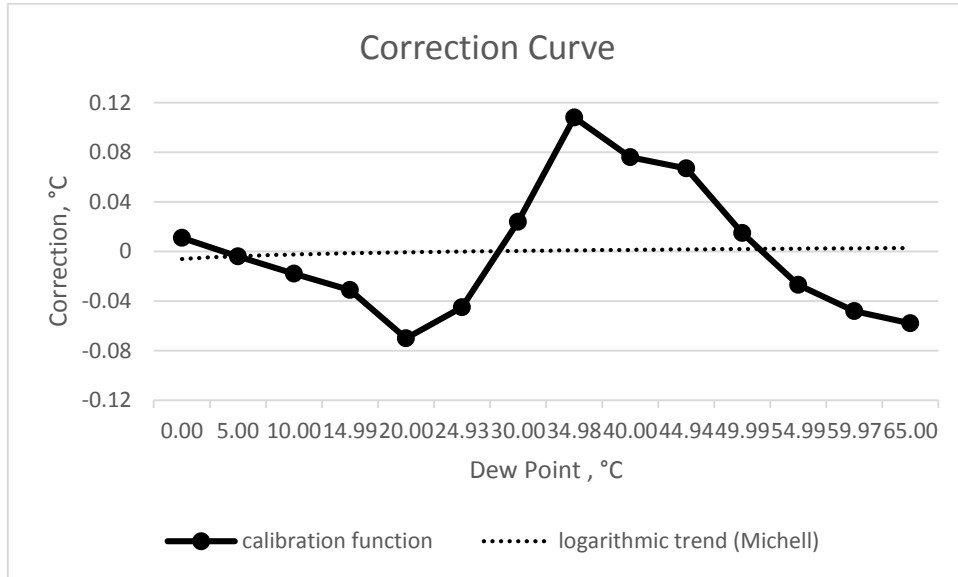

Graph 7 - The graph shows the correction curve of the Michell calibration

The calibration uncertainty exposed in the table 8 includes the uncertainty from Michell repeatability.

$$u_{rep} = \frac{|\max(\delta_T) - \min(\delta_T)|}{2 * \sqrt{3}} = 0.051 \text{ °C}$$

Then was combined with the chilled mirror hygrometer's uncertainty.

$$\begin{aligned} \text{Calibration Uncertainty} &= u_{CMH}(T) \\ &= \sqrt{u_{2500}(T)^2 + u_{std2500}(T)^2 + u_{Sensor}(T)^2 + u_{rep}(T)^2} \end{aligned}$$

The calibration permits to use the Michell hygrometer as a transfer device for comparison purposes between the prototype and the standard HG, is then proceed to set the calibrated hygrometer in the bench test.

5.4.2.2.-Saturation temperature uncertainty

Inside the saturator the temperature is measured with a standard PRT-100 which calibration certificate and characteristic equation is given by the Istituto Nazionale di Ricerca Metrologica INRIM – Turin, Italy.

The calibration's uncertainty given is $u_{PRT} = 0.015 K$ and the characteristic equation is:

$$R(T) = R_0(1 + \alpha T + \beta T^2)$$

$$R_0 = 100.0156 [\Omega]$$

$$\alpha = 0.003985 [^{\circ}C^{-1}]$$

$$\beta = -5.91 \times 10^{-7} [^{\circ}C^{-2}]$$

The saturation temperature's uncertainty is estimated by the combination of the calibration uncertainty and the standard deviation.

$$u_{med}(T) = std(T)$$

$$u_{PRT} = 0.015 K$$

$$u(T_{sat}) = \sqrt{u_{PRT}(T)^2 + u_{std}(T)^2}$$

Once the uncertainty components coming from the saturation and dew point measurements are estimated is proceed to calculate the total combined uncertainty as:

$$u(T_{sat} - T_{CMH}) = \sqrt{u_{CMH}(T)^2 + u_{PRT}(T)^2 + u_{std}(T)^2}$$

5.5.-Validation tests

The test at atmospheric pressure is performed to validate the prototype capabilities varying the saturation temperature and the air flow.

$$\left\{ \begin{array}{l} P = 1.3 \text{ bar} \\ T_{sat} = 1, 10, 20, 30, 40, 50, 60, 70 [^{\circ}C] \\ \phi = 2, 4 [l/min] \end{array} \right.$$

For the data analysis one must select periods where the saturation and the dew point temperatures are stable in time. In the graph below is Plotted the data obtained for $T_{sat-set\ point} = 10^{\circ}C$ with a flow of $\phi = 2[liter/min]$.

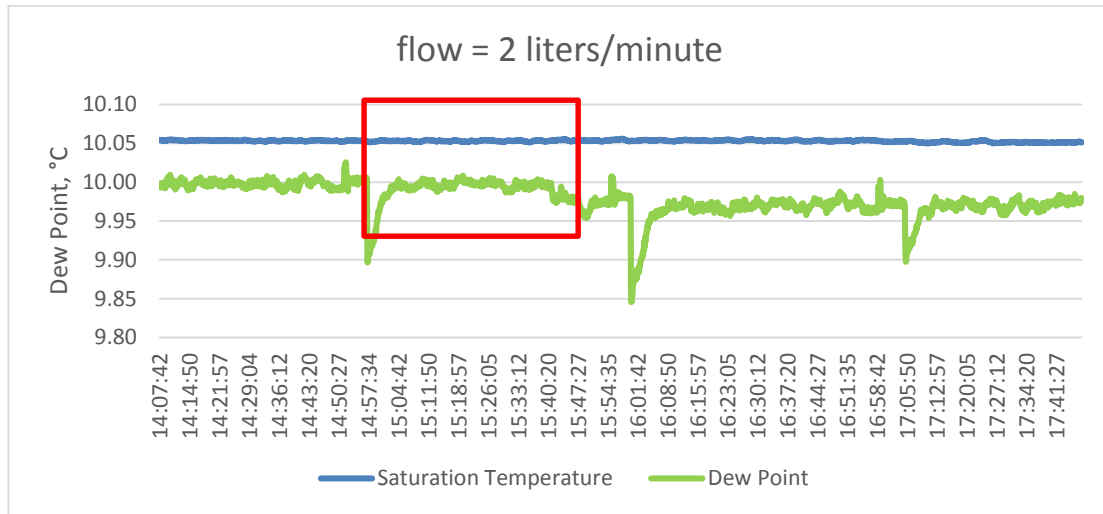

Graph 8 – Validation test at 10°C set point

During the tests can be noticed a transitory data corresponded to the mirror check and other random-uncontrollable variables. Ignoring the unstable regions we select the highlighted period.

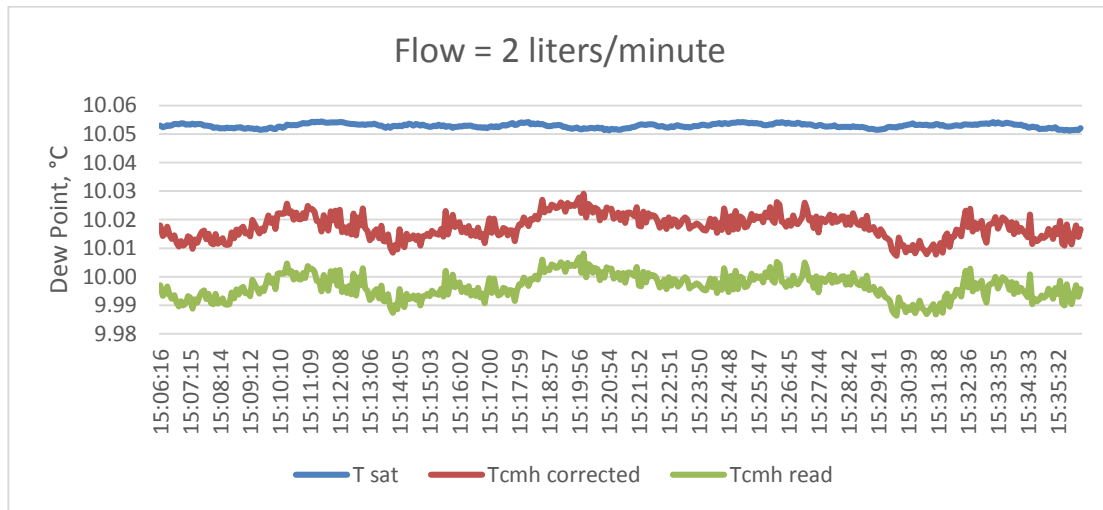

Graph 9 – Selected stable range with dew point measured and corrected

The blue curve represents the saturation temperature, while the red one is the dew point corrected by the factor δ_T .

This selection process permits to compare the prototype and the standard characteristics under controlled conditions. It is proceed to graph the selected data of $T_{CMH} - T_{sat}$ with the standard combined uncertainty band $k = 1$.

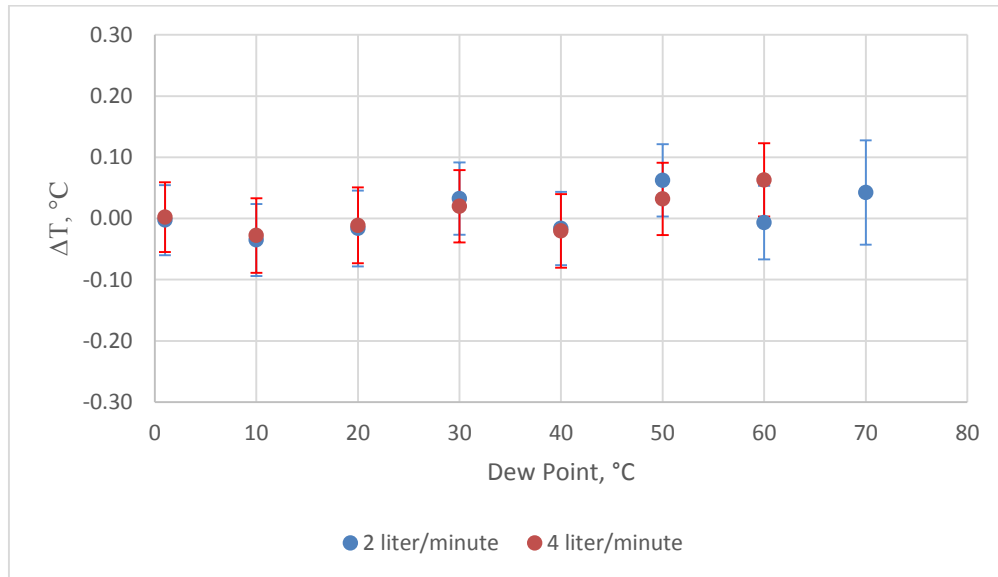

Graph 10 – Results with a confidence level of 68.2%

The difference between dew point and saturation temperatures will have a normal distribution around the mean value $\mu = \overline{T_{CMH} - T_{sat}}$.

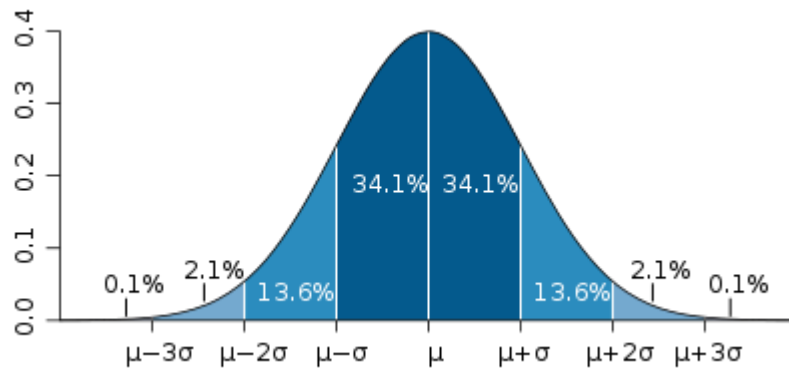

Graph 11

Using the standard uncertainty –coverage factor of $k = 1$ - it is ensured a level of confidence of 68.2% inside the band shown in the graph 11, this means that 31.8% of the results may not be covered by the estimations, which is a very large and unacceptable value. It is also observed that some results does not satisfy the prototype’s validation criteria of $|T_{CMH} - T_{sat}| \leq u(\Delta T)$.

It is desiderated to ensure a higher level of confidence of 95.4% -coverage factor of $k = 2$ -, it is proceed to compare the uncertainty values including both, standard and expanded uncertainty.

Flow [l/min]	$T_{CMH} + \delta_p$ [°C]	T_{sat} [°C]	$u(\Delta T)$ [°C] $k = 1$	$U(\Delta T)$ [°C] $k = 2$
2	1.11	1.11	0.057	0.114
2	10.02	10.05	0.059	0.118
2	20.03	20.04	0.062	0.124
2	30.07	30.04	0.059	0.118
2	40.03	40.05	0.060	0.120
2	50.12	50.05	0.059	0.118
2	60.00	60.01	0.060	0.120
2	70.09	70.05	0.085	0.171
4	1.11	1.11	0.057	0.114
4	10.02	10.05	0.061	0.122
4	20.03	20.04	0.062	0.124
4	30.06	30.04	0.059	0.118
4	40.03	40.05	0.060	0.120
4	50.08	50.05	0.059	0.118
4	60.06	60.00	0.060	0.120

Table 10 – Validation results

Rebuilding the graph using the coverage factor of 2.

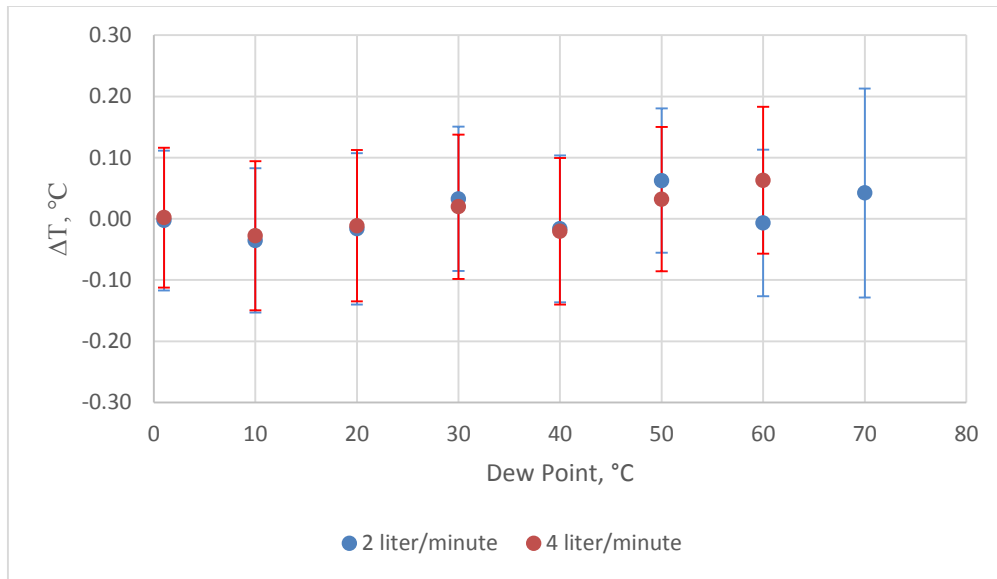

Graph 12 – Results with a confidence level of 95.4%

From the graph is observed that the validation criteria is satisfied.

$$|T_{CMH} - T_{sat}| \leq U(T_{CMH} - T_{sat})$$

As consequence the prototype working at ambient pressure and temperatures from 0 and 70°C dew point is validated respect of a standard humidity generator with a maximum uncertainty of $U = 0.171$ °C.

5.6.-Testing at Higher pressure

Testing at higher pressure require special focusing in some operational aspects to ensure time-stable regions that permits the validation procedure, the largest inconvenient is related to the test hygrometer stability which is influenced negatively by the pressure, when the mirror check is performed it takes more time to stabilize the measurements, decreasing the amount of useful data.

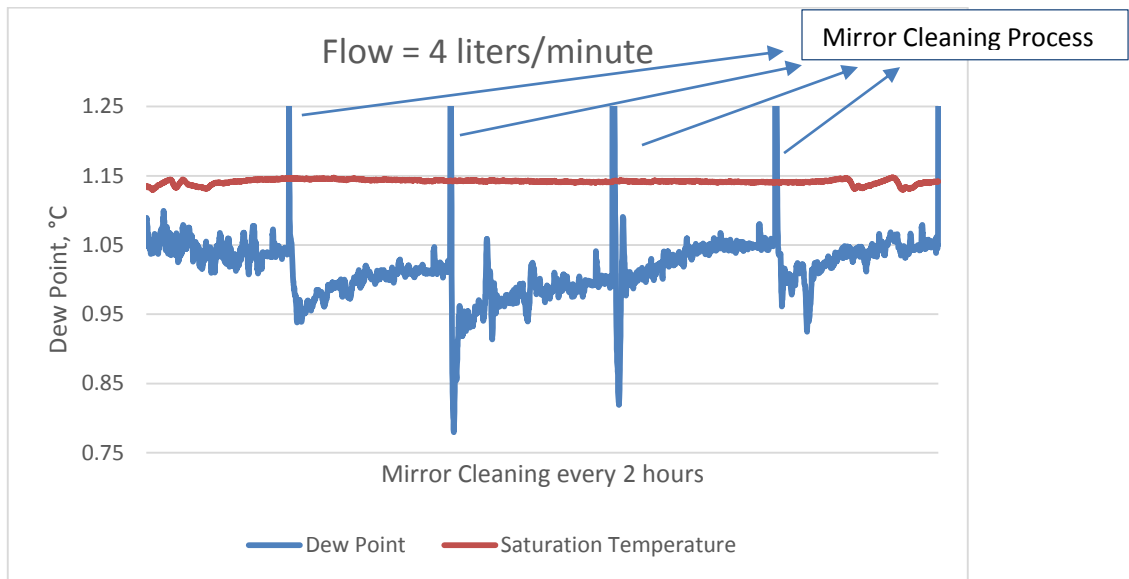

Graph 13 – The saturation and dew point temperatures are measured at a flow of 4 liter per minute

The graph above shows the chilled mirror hygrometer's instabilities, rendering impossible to obtain time stable regions for the validation purposes; the same behavior is noticeable at lower air flow rates as is shown in the following graph.

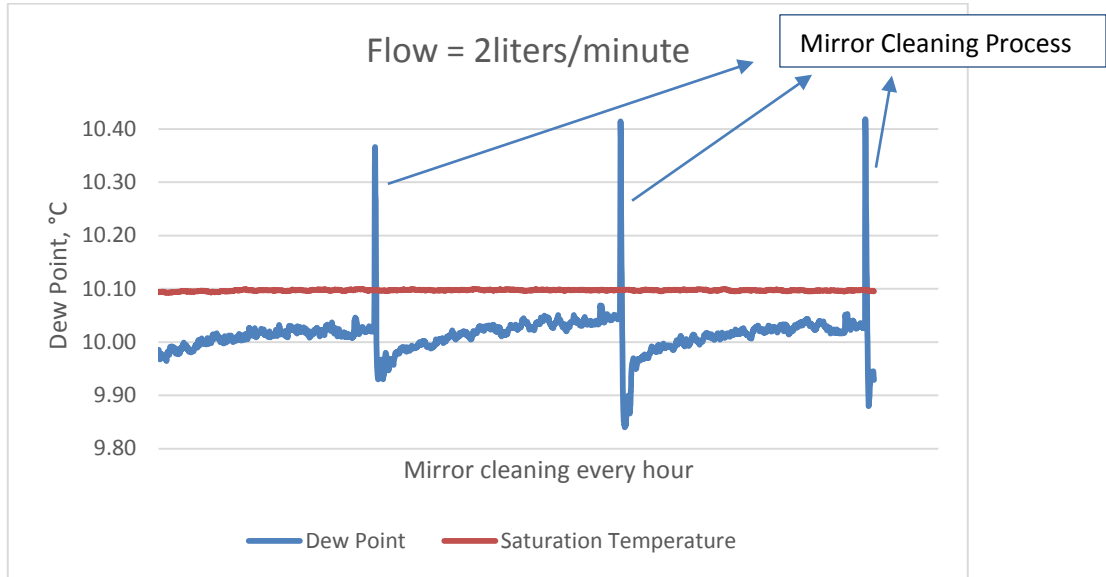

Graph 14 – Testing at 3 bar

The red curves shows a relative stable behavior insinuating that the generator can successfully work at $P = 3 \text{ bar}$; if one graph only the saturation temperature in time function.

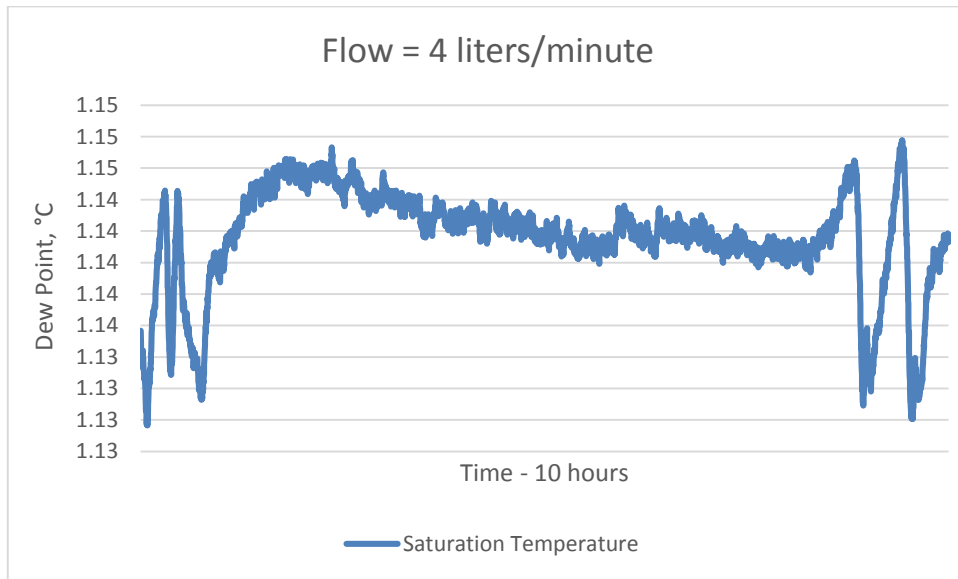

Graph 15 – Saturation temperature at 4 liter per minute and 3 bar

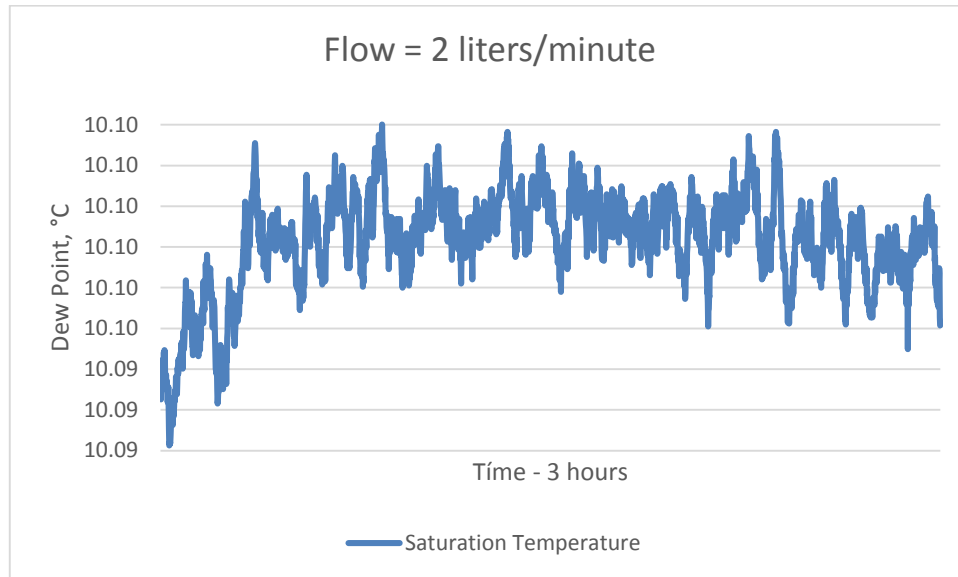

Graph 16 – Saturation temperature at 2 liters per minute and 3 bar

The saturation temperature vary under very restricted region $std(T_{sat}) = 0.00431263$ °C in the most unstable case, this may allow to hypothesize that the system can probably successfully work at a pressure of 3 bar but it is necessary further tests using a stable hygrometer to be validated.

CHAPTER 6 – CONCLUSIONS

The experimental tests carried out have validated the performance of a PHE-based humidity generator against a primary standard at any dew-point temperature between 0 and 70°C. The system showed no dependency on the volumetric flow from 0 to 60°C.

At 70 °C dew-point the system showed higher uncertainty $U = 0.17$ °C, but working under less extreme thermal loads the system was able to work with a maximum uncertainty of $U = 0.12$ °C. It was observed that the Michells hygrometer showed poor repeatability respect of other chilled mirror hygrometers.

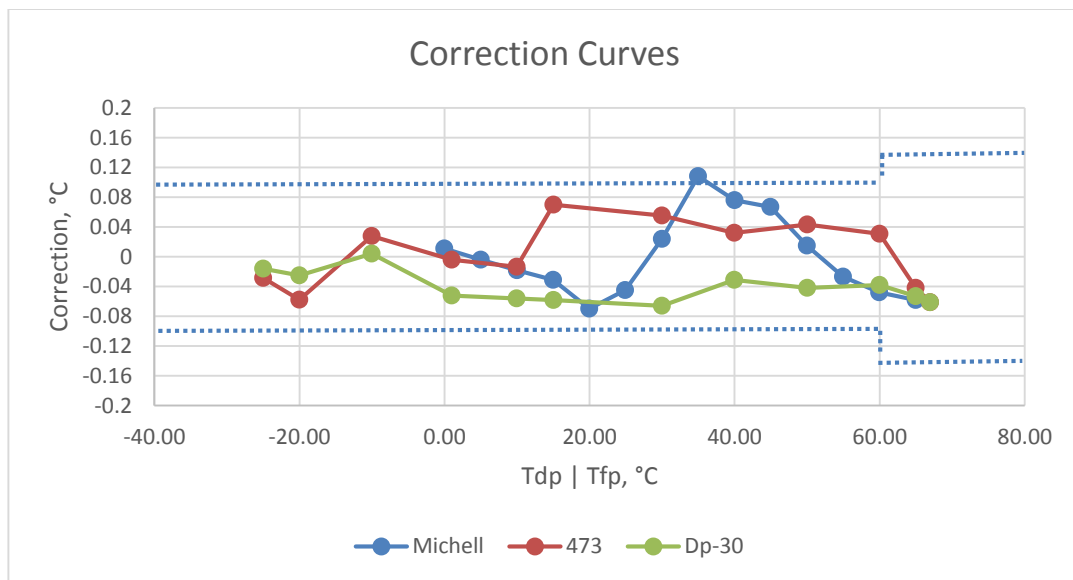

Graph 17 – Correction curves of 3 different chilled mirror hygrometers of the calibration

The graph 14 shows the calibration curve of three diverse hygrometers, exposing the poor repeatability of Michell hygrometer respect of Dp-30 MBW.

Beyond the atmospheric pressure was not possible to validate the HG prototype due to the unstable behavior of the chilled mirror hygrometer, this suggest for further tests seeking to improve the stability of measurements.

Appendix A

Mean				
Generator Frost Point	Generator Dew Point	DP-30 MWB	473 Dew Point	473 Frost Point
-25.00	-27.70	-25.04	-27.72	-25.02
-25.00	-27.70	-25.00	-27.74	-25.04
-20.00	-22.25	-20.02	-22.29	-20.03
-20.00	-22.25	-20.04	-22.31	-20.05
-19.99	-22.24	-22.35	-22.33	-20.07
-19.98	-22.23	-19.99	-22.29	-20.03
-8.90	-10.01	-9.99	-9.96	-8.86
-8.91	-10.01	-10.03	-10.00	-8.90
1.00	1.00	0.95	0.99	0.99
1.00	1.00	0.95	1.00	1.00
1.00	1.00	0.95	1.00	1.00
1.01	1.01	0.96	1.00	1.00
1.01	1.01	0.96	1.01	1.01
1.02	1.02	0.96	1.01	1.01
1.02	1.02	0.97	1.01	1.01
1.02	1.02	0.97	1.02	1.02
1.02	1.02	0.97	1.02	1.02
1.03	1.03	0.98	1.03	1.03
1.03	1.03	0.98	1.03	1.03
9.98	9.98	9.92	9.96	9.96
9.97	9.97	9.92	9.96	9.96
9.97	9.97	9.92	9.96	9.96
15.00	15.00	14.94	14.99	14.99
15.00	15.00	14.95	15.01	15.01
15.01	15.01	14.95	15.00	15.00
15.01	15.01	14.95	15.01	15.01
15.02	15.02	14.97	15.01	15.01
15.03	15.03	14.97	15.02	15.02
15.03	15.03	14.97	15.82	15.82
15.00	15.00	14.94	14.99	14.99
15.01	15.01	14.95	14.99	14.99
15.01	15.01	14.95	15.00	15.00
30.00	30.00	29.94	30.08	30.08

30.00	30.00	29.93	30.05	30.05
30.00	30.00	29.94	30.08	30.08
30.00	30.00	29.93	30.03	30.03
30.00	30.00	29.93	30.06	30.06
29.99	29.99	29.92	30.04	30.04
29.99	29.99	29.92	30.04	30.04
29.99	29.99	29.92	30.02	30.02
39.99	39.99	39.94	40.07	40.07
39.99	39.99	39.95	40.08	40.08
39.98	39.98	39.93	40.04	40.04
39.98	39.98	39.93	40.04	40.04
39.97	39.97	39.91	40.01	40.01
39.96	39.96	39.91	40.02	40.02
40.00	40.00	39.95	40.05	40.05
39.99	39.99	39.93	40.03	40.03
39.99	39.99	39.93	40.03	40.03
40.00	40.00	40.12	40.12	40.12
39.96	39.96	40.00	40.00	40.00
39.98	39.98	40.03	40.03	47.78
39.96	39.96	39.99	39.99	39.99
40.00	40.00	40.03	40.03	40.03
40.00	40.00	40.03	40.03	40.03
39.98	39.98	39.93	39.98	39.98
39.97	39.97	39.92	39.98	39.98
39.97	39.97	39.90	39.96	39.96
39.96	39.96	39.89	39.96	39.96
40.00	40.00	39.94	40.00	40.00
39.99	39.99	39.93	39.99	39.99
39.98	39.98	39.92	39.98	39.98
39.98	39.98	39.92	39.98	39.98
39.96	39.96	39.90	39.96	39.96
39.96	39.96	39.90	39.96	39.96
50.00	50.00	49.96	50.05	50.05
49.99	49.99	49.95	50.04	50.04
49.99	49.99	49.96	50.04	50.04
50.00	50.00	49.95	50.03	50.03
50.00	50.00	49.96	50.04	50.04
50.01	50.01	49.96	50.04	50.04
50.01	50.01	49.97	50.06	50.06
50.02	50.02	49.97	50.06	50.06
50.01	50.01	49.97	50.06	50.06

60.00	60.00	59.97	60.04	60.04
60.00	60.00	59.96	60.04	60.04
59.99	59.99	59.96	60.02	60.02
59.99	59.99	59.94	60.01	60.01
65.00	65.00	64.97	65.01	65.01
65.00	65.00	64.97	65.02	65.02
65.01	65.01	64.98	65.02	65.02
65.01	65.01	64.98	65.02	65.02
64.98	64.98	64.92	64.92	64.92
65.00	65.00	64.94	64.94	64.94
64.99	64.99	64.93	64.93	64.93
64.99	64.99	64.92	64.92	64.92
64.98	64.98	64.91	64.91	64.91
64.97	64.97	64.90	64.90	64.90
64.95	64.95	64.89	64.89	64.89
65.00	65.00	64.93	64.93	64.93
65.00	65.00	64.94	64.94	64.94
64.99	64.99	64.94	64.94	64.94
64.98	64.98	64.92	64.92	64.92
66.99	66.99	66.93	66.93	66.93
66.96	66.96	66.90	66.90	66.90
66.94	66.94	66.88	66.88	66.88
66.97	66.97	66.91	66.91	66.91
66.97	66.97	66.91	66.91	66.91
66.95	66.95	66.89	66.89	66.89

Table 11

**Standard
Deviation**

Generator Frost Point	Generator Dew Point	DP-30 MWB	473 Dew Point	473 Frost Point
2.71E-02	2.94E-02	0.01	0.01	0.01
2.52E-02	2.73E-02	0.01	0.31	0.29
6.91E-03	7.55E-03	0.01	0.02	0.02
1.69E-02	1.85E-02	0.02	0.02	0.02
7.90E-03	8.63E-03	0.02	0.01	0.01
1.28E-02	1.40E-02	0.02	0.02	0.02
3.31E-03	3.69E-03	0.02	0.02	0.01
2.52E-03	2.81E-03	0.01	0.01	0.01
5.63E-03	5.63E-03	0.01	0.01	0.01
4.60E-03	4.60E-03	0.01	0.01	0.01

4.44E-03	4.44E-03	0.01	0.01	0.01
3.95E-03	3.95E-03	0.01	0.01	0.01
5.45E-03	5.45E-03	0.01	0.01	0.01
4.82E-03	4.82E-03	0.01	0.01	0.01
4.25E-03	4.25E-03	0.01	0.01	0.01
1.08E-02	1.08E-02	0.01	0.01	0.01
6.10E-03	6.10E-03	0.01	0.01	0.01
7.26E-03	7.26E-03	0.01	0.01	0.01
3.98E-03	3.98E-03	0.01	0.01	0.01
7.36E-03	7.36E-03	0.01	0.01	0.01
6.25E-03	6.25E-03	0.01	0.01	0.01
6.47E-03	6.47E-03	0.01	0.01	0.01
4.53E-03	4.53E-03	0.01	0.01	0.01
4.67E-03	4.67E-03	0.01	0.01	0.01
5.62E-03	5.62E-03	0.01	0.01	0.01
5.23E-03	5.23E-03	0.01	0.01	0.01
4.93E-03	4.93E-03	0.01	0.01	0.01
4.71E-03	4.71E-03	0.01	0.01	0.01
5.27E-03	5.27E-03	0.01	3.98	3.98
5.18E-03	5.18E-03	0.01	0.01	0.01
5.76E-03	5.76E-03	0.01	0.01	0.01
5.56E-03	5.56E-03	0.01	0.01	0.01
2.69E-03	2.69E-03	0.01	0.01	0.01
3.00E-03	3.00E-03	0.01	0.01	0.01
3.11E-03	3.11E-03	0.01	0.01	0.01
3.21E-03	3.21E-03	0.01	0.01	0.01
2.92E-03	2.92E-03	0.01	0.01	0.01
2.80E-03	2.80E-03	0.01	0.00	0.00
2.94E-03	2.94E-03	0.01	0.00	0.00
3.48E-03	3.48E-03	0.01	0.01	0.01
3.68E-03	3.68E-03	0.01	0.01	0.01
3.28E-03	3.28E-03	0.01	0.00	0.00
3.29E-03	3.29E-03	0.01	0.01	0.01
3.21E-03	3.21E-03	0.01	0.00	0.00
4.09E-03	4.09E-03	0.01	0.01	0.01
4.14E-03	4.14E-03	0.01	0.01	0.01
3.78E-03	3.78E-03	0.01	0.01	0.01
2.77E-03	2.77E-03	0.01	0.00	0.00
2.77E-03	2.77E-03	0.01	0.00	0.00

3.51E-03	3.51E-03	0.01	0.01	0.01
3.59E-03	3.59E-03	0.01	0.01	0.01
2.77E-03	2.77E-03	0.00	0.00	12.74
3.70E-03	3.70E-03	0.01	0.01	0.01
3.70E-03	3.70E-03	0.01	0.01	0.01
3.78E-03	3.78E-03	0.01	0.01	0.01
6.04E-03	6.04E-03	0.01	0.01	0.01
7.31E-03	7.31E-03	0.01	0.01	0.01
1.09E-02	1.09E-02	0.01	0.01	0.01
1.09E-02	1.09E-02	0.01	0.01	0.01
1.05E-02	1.05E-02	0.01	0.01	0.01
9.59E-03	9.59E-03	0.01	0.01	0.01
1.06E-02	1.06E-02	0.01	0.01	0.01
9.19E-03	9.19E-03	0.01	0.01	0.01
1.02E-02	1.02E-02	0.01	0.01	0.01
1.01E-02	1.01E-02	0.01	0.01	0.01
4.74E-03	4.74E-03	0.01	0.01	0.01
4.40E-03	4.40E-03	0.01	0.01	0.01
4.71E-03	4.71E-03	0.01	0.01	0.01
4.77E-03	4.77E-03	0.01	0.01	0.01
3.97E-03	3.97E-03	0.01	0.01	0.01
5.20E-03	5.20E-03	0.01	0.01	0.01
4.29E-03	4.29E-03	0.01	0.01	0.01
8.46E-03	8.46E-03	0.01	0.01	0.01
1.40E-02	1.40E-02	0.02	0.01	0.01
4.87E-03	4.87E-03	0.01	0.01	0.01
5.73E-03	5.73E-03	0.01	0.01	0.01
4.70E-03	4.70E-03	0.01	0.01	0.01
1.01E-02	1.01E-02	0.01	0.01	0.01
3.43E-03	3.43E-03	0.01	0.01	0.01
3.67E-03	3.67E-03	0.01	0.01	0.01
3.86E-03	3.86E-03	0.01	0.01	0.01
2.98E-03	2.98E-03	0.01	0.00	0.00
2.90E-03	2.90E-03	0.00	0.00	0.00
4.00E-03	4.00E-03	0.01	0.01	0.01
3.48E-03	3.48E-03	0.00	0.00	0.00
6.82E-03	6.82E-03	0.01	0.01	0.01
6.52E-03	6.52E-03	0.01	0.01	0.01
6.85E-03	6.85E-03	0.01	0.01	0.01

7.71E-03	7.71E-03	0.01	0.01	0.01
9.18E-03	9.18E-03	0.01	0.01	0.01
3.61E-03	3.61E-03	0.01	0.01	0.01
3.16E-03	3.16E-03	0.00	0.00	0.00
3.80E-03	3.80E-03	0.01	0.01	0.01
2.60E-03	2.60E-03	0.00	0.00	0.00
3.32E-03	3.32E-03	0.00	0.00	0.00
2.48E-03	2.48E-03	0.00	0.00	0.00
3.05E-03	3.05E-03	0.00	0.00	0.00
2.65E-03	2.65E-03	0.00	0.00	0.00
2.23E-03	2.23E-03	0.00	0.00	0.00

Table 12

–22°C Dew point measured with DP-30

During the DP-30 calibration process have been measured a dew-point temperature of $T_{dp} = -22.24\text{ }^{\circ}\text{C}$ at atmospheric pressure, at those humidity levels the stable state corresponds to frost point $T_{fp} = -19.99\text{ }^{\circ}\text{C}$. The results was obtained after a mirror check process at frost point set of $T_{fp} = -20\text{ }^{\circ}\text{C}$ and upstream of mirror check process the DP-30 measured frost-point.

It is few likely to measure dew at temperatures below $-10\text{ }^{\circ}\text{C}$ and this point represents a metastable state. There had been the option to assume this value as a valid dew point without paying attention to deeper physicochemical aspects. But due to repeatability problems has been ignored for further calculations.

APPENDIX B

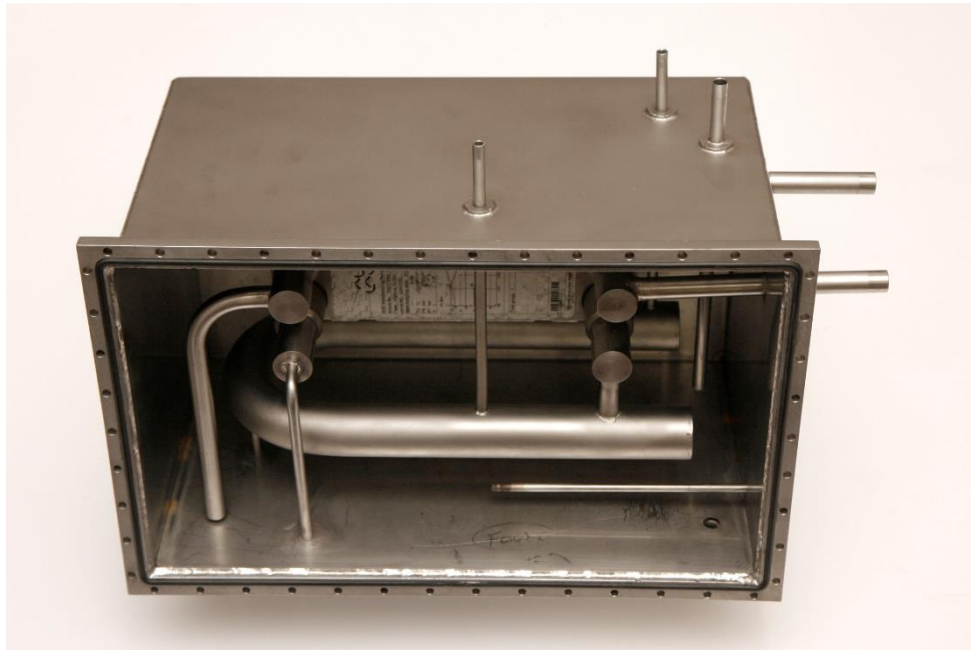

Figure 45

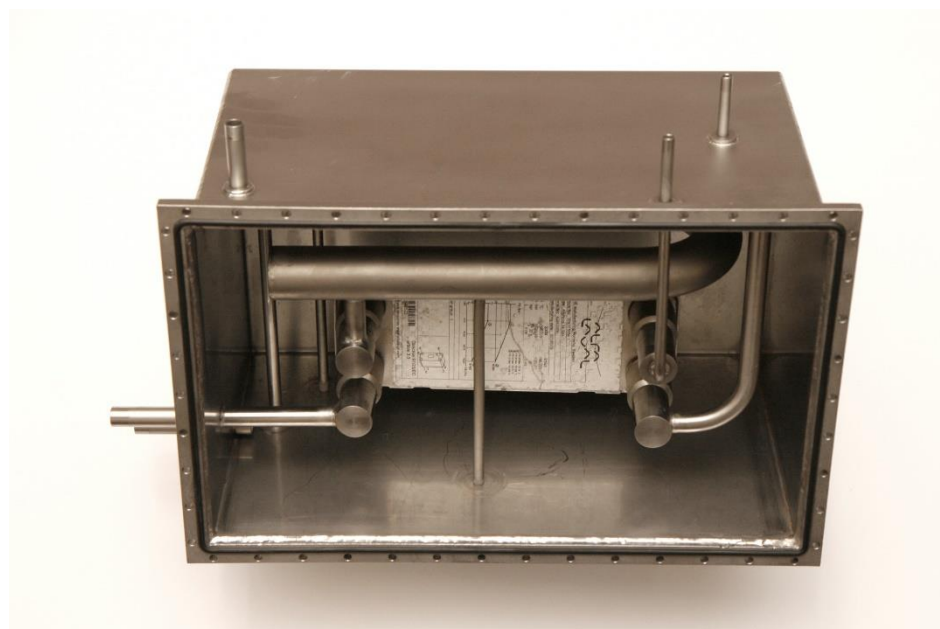

Figure 46



Figure 47

REFERENCES

- [1] <http://en.wikipedia.org/wiki/Psychrometrics>
- [2] Appunti Applicazioni Avanzate di Fisica Tecnica - prof. Borchellini
- [3] Meteorologic Measurement Systems – Fred V. Brock, Scott J. Richardson
- [4] Paul A., Tipler; Gene Mosca (2008). *Physics for Scientists and Engineers, Volume 1* (6th ed.). New York, NY: Worth Publishers. pp. 666–670. ISBN 1-4292-0132-0.
- [5] Principles and Methods of Temperature Measurement – Thomas D. McGee
- [6] en.wikipedia.org/wiki/Diffusion Consulted on 10/04//2015 at 16:42
- [7] Meteorologic Measurement Systems – Fred V. Brock, Scott J. Richardson
- [8] Humidity and Moisture (1970) – Arnold Wexler
- [9] Water Vapor Measurements – Pieter R. Wiederhold
- [10] es.mt.com/es/es/home/supportive_content/application_editorials/Moisture_determination_by_Karl_Fischer_1.html Consulted on 27/08/2015 at 12:03 pm
- [11] *JCGM 200:2008 International vocabulary of metrology* — Basic and general concepts and associated terms (VIM)
- [12] Procedimiento TH-007 para la calibración de medidores de condiciones ambientales de temperatura y humedad en aire – Centro Español de Meteorología.
- [13] Evaluación de datos de medición, Guía para la expresión de la Incertidumbre de medida – Centro Español de Meteorología.
- [14] es.wikipedia.org/wiki/Acrilamida consulted on 19/05/2015 at 4:20 pm
- [15] heatox.org/
- [16] Yasuhara, A., Tanaka, Y., Hengel, M., & Shibamoto, T. (2003). Gas chromatographic investigation of acrylamide formation in browning model systems. *Journal of Agricultural and Food Chemistry*.

-
- [17] Özge G. Açar, Vural Gökem, Investigation of acrylamide formation on bakery products using a crust-like model
- [18] www.scielo.org.mx/scielo.php?script=sci_arttext&pid=S1405-31952012000500001 Consulted on 22/05/2015 at 5:25 pm
- [19] en.wikipedia.org/wiki/1976_Philadelphia_Legionnaires%27_disease_outbreak Consulted on 11/04/2015 at 16:10
- [20] Handwerk, Brian (2005). «Egypt's “King Tut Curse” Caused by Tomb Toxins?». *National Geographic News* Consultado el 12 de junio de 2007.
- [21] www.scielo.cl/scielo.php?pid=S0717-75182007000100001&script=sci_arttext&tlng=pt Consulted on 19/05/2015 at 3:50 pm
- [22] Javad Keramat, Alain LeBaif, Carole Prost, Maryam, Acrylamide in Baking Products
- [23] www.pce-instruments.com/f/t/es/medicion-de-la-humedad-en-linea.htm Consulted on 23/05/2015 at 12:31 pm
- [24] V. Fericola, M. Banfo, *The IMG-CNR Humidity Facility for Hygrometers Calibration* (Proc.8th International Symposium on Temperature and Thermal Measurements in Industry and Science - TEMPMEKO 2001, Berlin, Germany, 2001, Vol. 2, pp. 751-756)
- [25] C.W. Meyer, W.W. Miller, D.C. Ripple, G. E. Scace, *Uncertainty Budget for the NIST Hybrid Humidity Generator* (Proc.8th International Symposium on Temperature and Thermal Measurements in Industry and Science - TEMPMEKO 2001, Berlin, Germany, 2001, Vol. 2, pp. 751-756)
- [26] Drago Groselj. WMO CIMO Training Workshop on Metrology for the English-speaking countries of Region V (South-West Pacific) - Training Workshop on Metrology, Melbourne, Australia.
- [28] www.thunderscientific.com/tech_support/support_docs/2-press-cal.html
- [29] www.nist.gov/pml/div685/grp01/co2-dew-point.cfm Consulted on 10/04/2015 at 10:52 am
- [30] C. W. Meyer, W. W. Miller, D. C. Ripple, G. E. Scace. *Uncertainty Budget for the NIST Hybrid Humidity Generator* (Proc.8th International journal of thermophysics- TEMPMEKO & ISHM 2010, Berlin, Germany, 2010, Vol. 33, pp. 1488-1499)

-
- [31] Vito C. Fericola, Mauro Banfo, A Dilution and Mixing Stage for a Frost Point Humidity Generator
- [32] V. Fericola, G. Beltramino, D. Smorgon, Application of plate heat exchangers to the development of portable high-pressure humid gas generators -10th International conference of heat transfer, fluid mechanics and thermodynamics, Orlando Florida-.
- [33] Alfa Laval, Intercambiador de calor modelo AlfaNova 14
- [34] www.hisaka.co.jp/english/phe/product/phe_structure.html Consulted on 25/05/2015 at 12:15 pm
- [35] Bayram Arman, Thomas J. Rabas, Condensation Analysis for Plate-Frame Heat Exchangers
- [36] Dong-Hyouck Han, Kyu-Jung Lee, Yoon-Ho Kim, The Characteristics of Condensation in Brazed Plate Heat Exchangers with Different Chevron Angles
- [37] Mark A. Kedzierski, Effect of Inclination on the Performance of a Compact Brazed Plate Condenser and Evaporator
- [38] thunderscientific.com/software/humicalc1.html
- [39] www.voegtlin.com
- [40] Markus Riederer, Katja Arand, Markus Burghardt, Hua Huang, Michael Riedel, Ann-Christin Schuster, Anna Smirnova, Yueming Jiang - Water loss from litchi (*litchi chinensis*) and longan (*Dimocarpus longan*) fruits is biphasic and controlled by a complex pericarpal transpiration barrier